

Service Manual

Air Conditioner



Indoor Unit
CS-E9RKUAW
CS-E12RKUAW
CS-E18RKUAW
CS-E24RKUAW

Outdoor Unit
CU-E9RKUA
CU-E12RKUA
CU-E18RKUA
CU-E24RKUA

Destination
USA
Canada

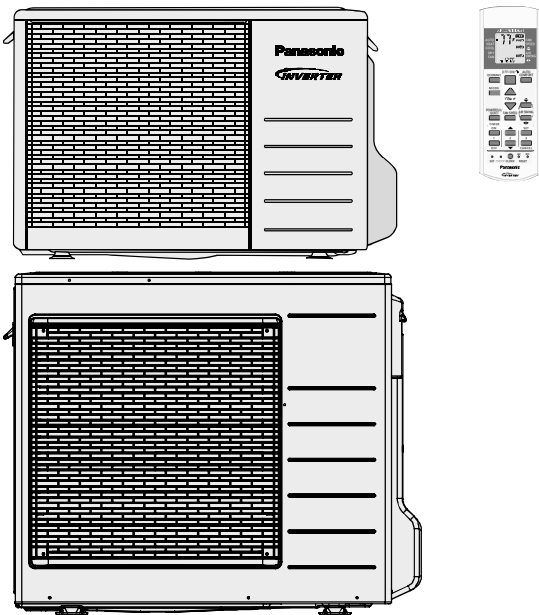

Please file and use this manual together with the service manual for Model No. CU-2E18NBU and CU-5E36QBU, Order No. PHAAM111120A1 and PAPAMY1312037CE.

WARNING

This service information is designed for experienced repair technicians only and is not designed for use by the general public. It does not contain warnings or cautions to advise non-technical individuals of potential dangers in attempting to service a product. Products powered by electricity should be serviced or repaired only by experienced professional technicians. Any attempt to service or repair the products dealt with in this service information by anyone else could result in serious injury or death.

PRECAUTION OF LOW TEMPERATURE

In order to avoid frostbite, be assured of no refrigerant leakage during the installation or repairing of refrigerant circuit.

22.1.2 CS-E18RKUAW CS-E24RKUAW

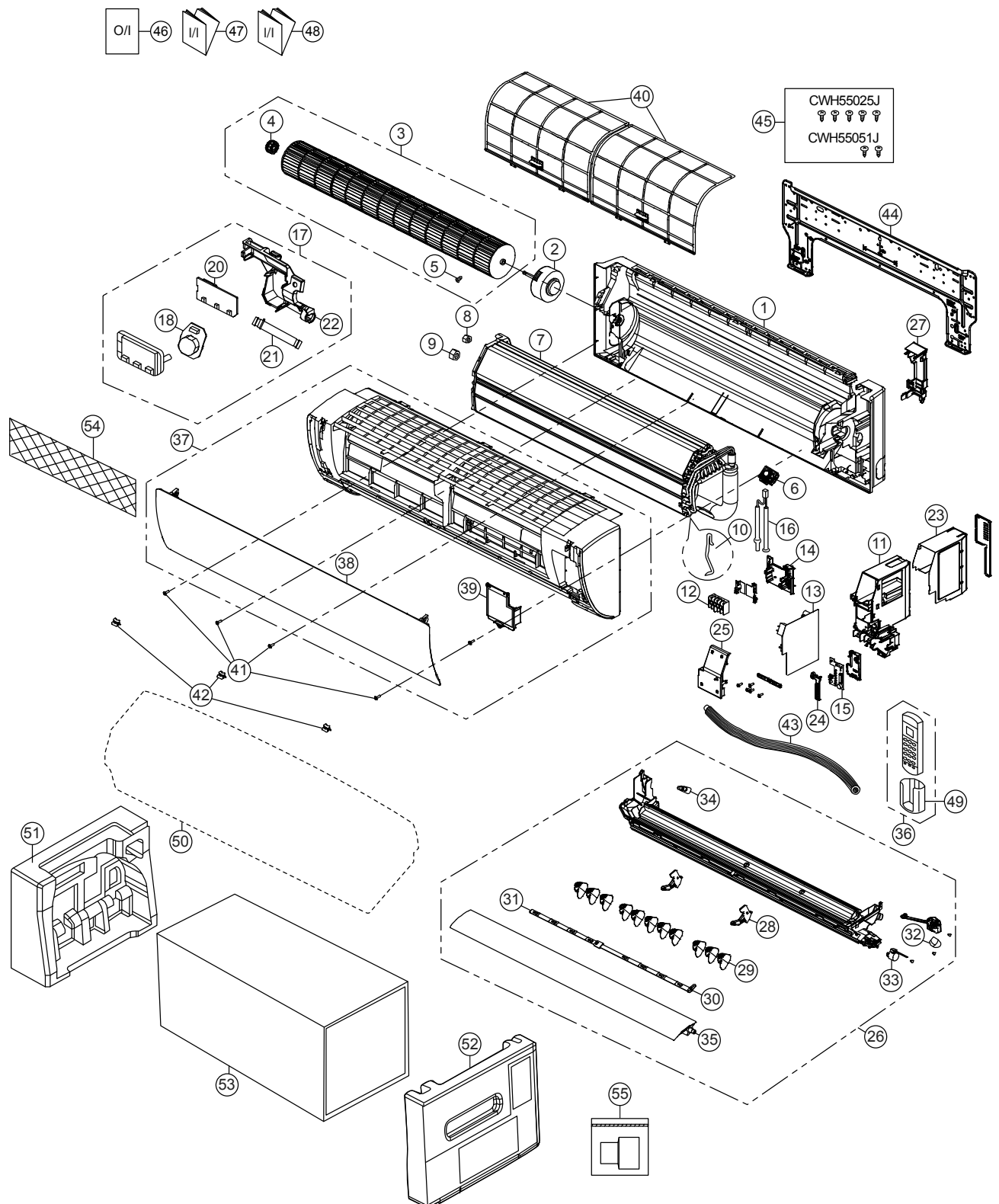

Note

The above exploded view is for the purpose of parts disassembly and replacement. The non-numbered parts are not kept as standard service parts.

SAFETY	REF. NO.	PART NAME & DESCRIPTION	QTY.	CS-E18RKUAW	CS-E24RKUAW	REMARK
	1	CHASSIS COMPLETE	1	CWD50C1637	←	
⚠	2	FAN MOTOR	1	L6CBYYL0056	←	O
	3	CROSS-FLOW FAN COMPLETE	1	CWH02C1077	←	
	4	BEARING ASSY	1	CWH64K007	←	O
	5	SCREW - CROSS-FLOW FAN	1	CWH551146	←	
	6	PARTICULAR PIECE	1	CWD933067	←	
	7	EVAPORATOR	1	CWB30C3963	CWB30C3967	
	8	FLARE NUT (LIQUID)	1	CWT251030	←	
	9	FLARE NUT (GAS)	1	CWT251032	CWT251033	
	10	CLIP FOR SENSOR	1	CWH32142	←	
	11	CONTROL BOARD CASING	1	CWH102605A	←	
⚠	12	TERMINAL BOARD COMPLETE	1	CWA28C2357	←	O
⚠	13	ELECTRONIC CONTROLLER - MAIN	1	CWA73C9158	CWA73C9159	O
	14	PARTICULAR PIECE - TERMINAL	1	CWD933137A	←	
⚠	15	ELECTRONIC CONTROLLER-INDICATOR	1	CWA748158	←	O
	16	SENSOR COMPLETE	1	CWA50C3228	←	O
	17	SENSOR COMPLETE (ECO)	1	CWA50C2827	←	O
⚠	18	ELECTRONIC CONTROLLER (ECO SENSOR)	1	CWA745791	←	O
⚠	20	ELECTRONIC CONTROLLER (COMPARATOR)	1	CWA746769	←	O
	21	LEAD WIRE - PCB ECO	1	CWA67C9935	←	O
	22	CONTROL BOARD CASING FOR PCB ECO	1	CWD933455	←	
	23	CONTROL BOARD TOP COVER	1	CWH131467	←	
	24	INDICATOR HOLDER	1	CWD933406	←	
	25	CONTROL BOARD FRONT COVER CO.	1	CWH13C1333	←	
	26	DISCHARGE GRILLE COMPLETE	1	CWE20C3496	←	
	27	BACK COVER CHASSIS	1	CWD933031B	←	
	28	FULCRUM	1	CWH621138	←	
	29	VERTICAL VANE	11	CWE241374	←	
	30	CONNECTING BAR	1	CWE261257	←	
	31	CONNECTING BAR	1	CWE261258	←	
⚠	32	AIR SWING MOTOR ASS'Y.	1	CWA98K1024	←	
⚠	33	AIR SWING MOTOR	1	CWA981241	←	O
	34	CAP - DRAIN TRAY	1	CWH521259	←	
	35	HORIZONTAL VANE COMPLETE	1	CWE24C1392	←	
	36	REMOTE CONTROL COMPLETE	1	CWA75C4569	←	O
	37	FRONT GRILLE COMPLETE	1	CWE11C5961	←	O
	38	INTAKE GRILLE COMPLETE	1	CWE22C1945	←	
	39	GRILLE DOOR COMPLETE	1	CWE14C1131	←	
	40	AIR FILTER	2	CWD001283	←	O
	41	SCREW - FRONT GRILLE	3	XTT4+16CFJ	←	
	42	CAP - FRONT GRILLE	3	CWH521227	←	
	43	DRAIN HOSE	1	CWH851173	←	
	44	INSTALLATION PLATE	1	CWH361098	←	
	45	BAG COMPLETE - INSTALLATION SCREW	1	CWH82C1705	←	
	46	OPERATING INSTRUCTION	1	CWF569756	←	
	47	INSTALLATION INSTRUCTION	1	CWF616730	←	
	48	INSTALLATION INSTRUCTION	1	CWF616731	←	

SAFETY	REF. NO.	PART NAME & DESCRIPTION	QTY.	CS-E18RKUAW	CS-E24RKUAW	REMARK
	49	REMOTE CONTROL HOLDER	1	CWH361078	←	
	50	BAG	1	CWG861498	←	
	51	SHOCK ABSORBER (L)	1	CWG713402	←	
	52	SHOCK ABSORBER (R)	1	CWG713403	←	
	53	C.C. CASE	1	CWG567455	←	
	54	AIR PURIFYING FILTER	1	CWD00C1141	←	O
	55	BAG COMPLETE (TUBE CONNECTOR)	1	CWH82C2030	←	

(Note)

- All parts are supplied from PAPAMY, Malaysia (Vendor Code: 00029488).
- “O” marked parts are recommended to be kept in stock.