

Panasonic®

Operating Instructions Split System Air Conditioner



Model No.

Indoor Units

CS-KE30NKU

CS-KE36NKU

Outdoor Units

CU-KE30NKU

CU-KE36NKU

This air conditioner uses the refrigerant R410A.



Before operating the unit, read these operating instructions thoroughly and keep them for future reference.

Panasonic Corporation
1006 Kadoma, Kadoma City, Osaka, Japan

FEATURES

This air conditioner is an inverter type unit that automatically adjusts capability as appropriate. Details on these functions are provided below; refer to these descriptions when using the air conditioner.

- **Microprocessor Controlled Operation**
The interior compartment of the remote controller contains several features to facilitate automatic operation, easy logically displayed for easy use.
- **Simple One-touch Remote Controller**
The remote controller has several features to facilitate automatic operation.
- **24-Hour ON or OFF Timer**
This timer can be set to automatically turn the unit on or off at any time within a 24 hour period.
- **1-Hour OFF Timer**
This timer can be set to automatically turn off the unit at any time after one hour.
- **Night Setback**
This function saves energy by controlling operation to provide a quieter operating sound than normal.
- **Automatic and 3-step Fan Speed**
Auto/High/Medium/Low
- **Air Sweep Control**
This function moves a flap up and down in the air outlet, directing air in a sweeping motion around the room and providing comfort in every corner.
- **Auto. Flap Control**
This automatically sets the flap to the optimum position during heating, cooling, and drying operation.
- **Automatic Switching between Cooling and Heating**
This unit automatically switches between cooling operation and heating operation according to the difference between the room temperature and the temperature setting.
- **Hot Start Heating System**
Right from the start, the air is warm and comfortable. This system prevents any cold blasts at the beginning while the heat pump is warming up, or even defrosting.
- **Automatic Restart Function for Power Failure**
Even when power failure occurs, preset programmed operation can be reactivated once power resumes.
- **High Power Operation**
If not in Auto Operation, the unit operates at maximum output for 30 minutes, regardless of the desired temperature.
The fan speed is 1 step above "High".
- **Quiet Operation**
The fan rotates slower than the fan speed setting to provide a quieter operating sound.
- **Unoccupied**
This function prevents the room temperature from decreasing too much (or increasing too much) when no one is in the room, and operate automatically to save energy.

CONTENTS

	Page		Page
FEATURES.....	2	SPECIAL REMARKS	12
PRODUCT INFORMATION	2	SETTING THE TIMER	13
SAFETY PRECAUTIONS.....	2	USING THE 1-HOUR OFF TIMER	14
INSTALLATION LOCATION.....	3	TIPS FOR ENERGY SAVING	14
ELECTRICAL REQUIREMENTS	3	ADJUSTING THE AIRFLOW DIRECTION	15
SAFETY INSTRUCTIONS.....	3	OPERATION WITHOUT THE REMOTE CONTROLLER.....	15
NAMES OF PARTS	4	CARE AND CLEANING	16
USING THE REMOTE CONTROLLER	8	TROUBLESHOOTING (BEFORE CALLING FOR SERVICE) ..	17
OPERATION WITH THE REMOTE CONTROLLER.....	9	OPERATING RANGE.....	17
1. Automatic Operation	9	WIRED REMOTE CONTROLLER	17
2. Manual Operation.....	9	SPECIFICATIONS.....	18
3. Adjusting the Fan Speed.....	10		
4. Fan Only.....	10		
5. Night Setback Mode.....	10		
6. QUIET Mode	10		
7. HIGH POWER Mode.....	11		
8. UNOCCUPIED Mode.....	11		

PRODUCT INFORMATION

If you have problems or questions concerning your Air Conditioner, you will need the following information. Model and serial numbers are on the nameplate on the bottom of the cabinet.

Model No. _____

Serial No. _____

Date of purchase _____

Dealer's address _____

Phone number _____

SAFETY PRECAUTIONS

The following symbols used in this manual, alert you to potentially dangerous conditions to users, service personnel or the appliance:



WARNING

This symbol refers to a hazard or unsafe practice which can result in severe personal injury or death.



CAUTION

This symbol refers to a hazard or unsafe practice which can result in personal injury or product or property damage.

INSTALLATION LOCATION

- We recommend that this air conditioner be installed properly by qualified installation technicians in accordance with the Installation Instructions provided with the unit.
- Before installation, check that the voltage of the electric supply in your home or office is the same as the voltage shown on the nameplate.



WARNING

- Do not install this air conditioner where there are fumes or flammable gases, or in an extremely humid space such as a greenhouse.
- Do not install the air conditioner where excessively high heat-generating objects are placed.

Avoid:

To protect the air conditioner from heavy corrosion, avoid installing the outdoor unit where salty sea water can splash directly onto it or in sulphurous air near a spa.

ELECTRICAL REQUIREMENTS

1. All wiring must conform to the local electrical codes. Consult your dealer or a qualified electrician for details.
2. Each unit must be properly grounded with a ground (or earth) wire or through the supply wiring.
3. Wiring must be done by a qualified electrician.

NOTE

Pull off the power plug from a receptacle, or switch off the breaker, or switch off the power disconnecting mean to isolate the air conditioner from the main power supply when not in use for a long time.

SAFETY INSTRUCTIONS

- Read this Instruction Manual carefully before using this air conditioner. If you still have any difficulties or problems, consult your dealer for help.
- This air conditioner is designed to give you comfortable room conditions. Use this only for its intended purpose as described in this Instruction Manual.



WARNING

- Confirm to authorized dealer or specialist on usage of specified refrigerant type. Using of refrigerant other than the specified type may cause product damage, burst and injury etc.
- Never touch the unit with wet hands.
- Never use or store gasoline or other flammable vapor or liquid near the air conditioner — it is very dangerous.
- Do not use this appliance in a potentially explosive atmosphere.
- This air conditioner has no ventilator for intaking fresh air from outdoors. You must open doors or windows frequently when you use gas or oil heating appliances in the same room, which consume a lot of oxygen from the air. Otherwise there is a risk of suffocation in an extreme case.
- Do not swallow the battery.
- After removing the battery from remote controller, keep it away from the reach of children. The battery can cause death by suffocation if swallowed.
- When inserting the battery, make sure the polarities (+ and -) are correct.

- To prevent possible hazards from insulation failure, the unit must be grounded.
- Do not clean inside the indoor and outdoor units by users. Engage authorized dealer or specialist for cleaning.
- In case of malfunction of this appliance, do not repair by yourself. Contact to the sales dealer or service dealer for a repair.
- Refrigerant gas leakage may cause fire.
- For safety, be sure to turn the air conditioner off and also to disconnect the power before cleaning.
- Pull off the power plug from a receptacle, or switch off the breaker, or switch off the power disconnecting mean to isolate the air conditioner from the main power supply in case of emergency.



CAUTION

- Do not turn the air conditioner on and off from the power mains switch. Use the ON/OFF operation button.
- Do not stick anything into the air outlet of the outdoor unit. This is dangerous because the fan is rotating at high speed.
- Do not touch the air inlet or the sharp aluminum fins of the outdoor unit. You may get injured.
- Keep the fire alarm and the air outlet at least 1.5m away from the unit.
- Do not let children play with the air conditioner.
- Do not cool or heat the room too much if babies or invalids are present.
- Do not sit or step on the unit. You may fall down accidentally.
- Do not stick any object into the FAN CASE. You may be injured and the unit may be damaged.



NOTICE

- This device complies with part 15 of the FCC Rules. Operation is subject to the following two conditions: (1) This device may not cause harmful interference, and (2) this device must accept any interference received, including interference that may cause undesired operation.
- This equipment has been tested and found to comply with the limits for a Class B digital device, pursuant to part 15 of the FCC Rules. These limits are designed to provide reasonable protection against harmful interference in a residential installation. This equipment generates, uses and can radiate radio frequency energy and, if not installed and used in accordance with the instructions, may cause harmful interference to radio communications. However, there is no guarantee that interference will not occur in a particular installation. If this equipment does cause harmful interference to radio or television reception, which can be determined by turning the equipment off and on, the user is encouraged to try to correct the interference by one or more of the following measures:
 - Reorient or relocate the receiving antenna.
 - Increase the separation between the equipment and receiver.
 - Connect the equipment into an outlet on a circuit different from that to which the receiver is connected.
 - Consult the dealer or an experienced radio/TV technician for help.
- FCC Caution: To assure continued compliance, follow the attached installation instructions. Any changes or modifications not expressly approved by the party responsible for compliance could void the user's authority to operate this equipment.

NAMES OF PARTS

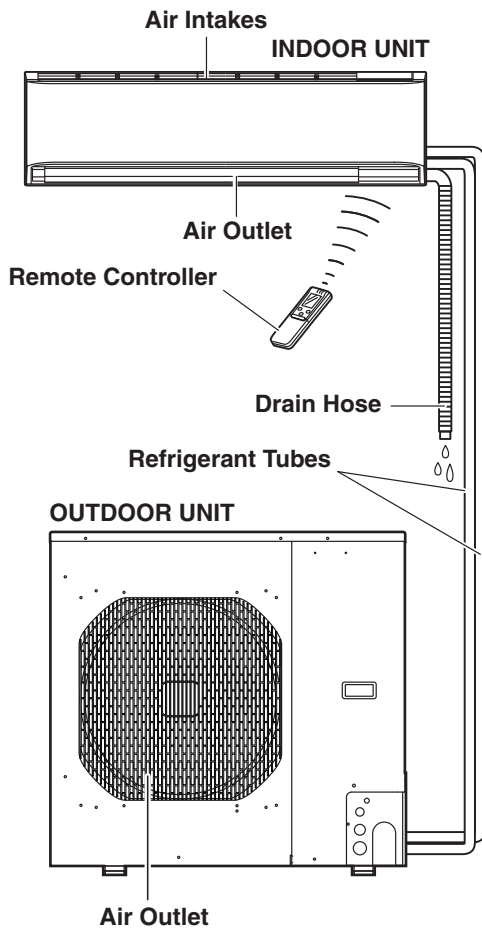

NOTE

This illustration is based on the external view of a standard model. Consequently, the shape may differ from that of the air conditioner which you have selected.

This air conditioner consists of an indoor unit and an outdoor unit. You can control the air conditioner with the remote controller.

Air Intake	Air from the room is drawn into this section and passes through air filters which remove dust.
Air Outlet	Conditioned air is blown out of the air conditioner through the air outlet.
Remote Controller	The remote controller controls power ON/OFF, operation mode selection, temperature, fan speed, timer setting, and air sweeping.
Refrigerant Tubes	The indoor and outdoor units are connected by copper tubes through which refrigerant gas flows.
Drain Hose	Moisture in the room condenses and drains off through this hose.
Outdoor (Condensing) Unit	The outdoor unit contains the compressor, fan motor, heat exchanger coil, and other electrical components.

UNIT DISPLAY AND OPERATION BUTTON

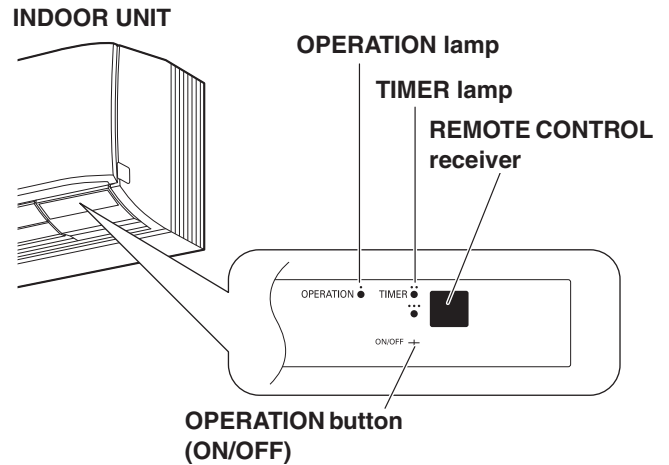

IMPORTANT

Avoid using radio equipment such as mobile phone near (within 4 ft. (1.2 m)) the remote control receiver. Some radio equipment may cause malfunction of the unit.

If the trouble happens, disconnect power and restart the air conditioner after a few minutes.

REMOTE CONTROL receiver	This section picks up infrared signals from the remote controller (transmitter).
OPERATION button	When the remote controller cannot be used, pressing this button enables heating and cooling operation. Each time this button is pressed, the type of operation conducted is indicated by the changing color of the OPERATION lamp. Press the button and select the lamp color that suits your preference for operation. Cooling operation (green) → Heating operation (red) → Stop (lamp off) ↑
OPERATION lamp	This lamp lights when the system is in the continuous AUTO (red or green), HEAT (red), DRY (orange), COOL (green) and FAN (green) mode. The OPERATION lamp lights up red and orange alternately when the system is defrosting.
TIMER lamp	This lamp lights when the system is being controlled by the timer.

NOTE

The unit's display lamps are dimmed during operation in the NIGHT SETBACK mode.

REMOTE CONTROLLER (DISPLAY)

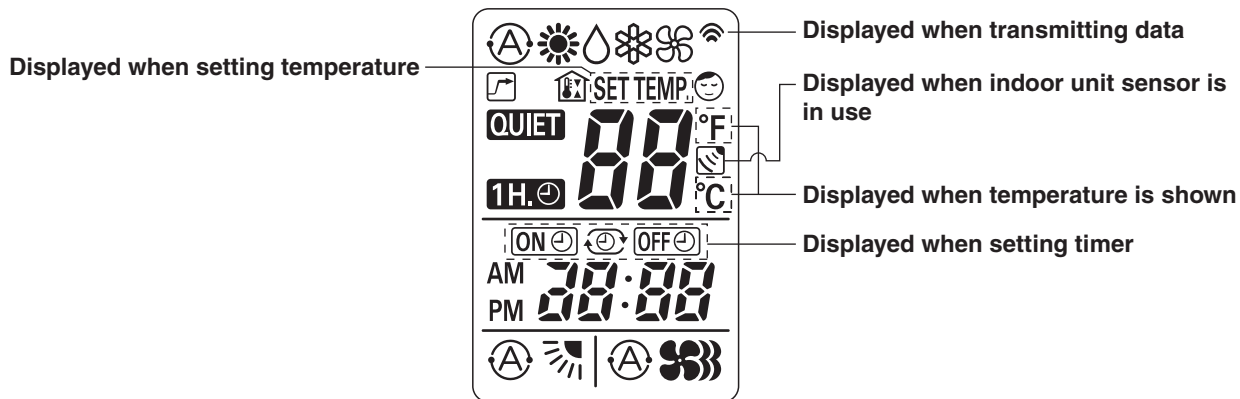

EG

Symbols

(1) Operation mode

- AUTO
- HEAT
- MILD DRY
- COOL
- FAN

(2) Fan speed

- Automatic operation
- HIGH
- MEDIUM
- LOW

(3) Temperature setting

- 60 – 86 °F
- When set to 80 °F temperature indication

(4) Timer

- 24-hour clock with ON/OFF program Timer
- ON Timer.
- OFF Timer.
- 1-hour OFF Timer.

- (5) NIGHT SETBACK
- (6) Confirmation of transmission
- (7) Auto. flap indication
- Flap angle indication
- Sweep indication
- (8) High power operation
- (9) UNOCCUPIED
- (10) Quiet operation

REMOTE CONTROLLER

Transmitter

When you press the buttons on the remote controller, the  mark appears in the display to transmit the setting changes to the receiver in the air conditioner.





Display

Information on the operating conditions is displayed while the remote controller is switched on. If the unit is turned off, FLAP setting and FAN SPEED setting are not displayed.

QUIET button



QUIET : When you press this button, the fan rotates slower than the fan speed setting to provide a quieter operating sound.

FAN SPEED selector button

-  : The air conditioner automatically decides the fan speeds.
-  : High fan speed
-  : Medium fan speed
-  : Low fan speed

FLAP button

Press this button either to select the setting of the airflow direction to the auto. flap in each mode or one of the six possible positions manually or to select the sweep function which moves the flap up and down automatically.

-  : Auto flap setting: If selected in a heating operation, the flap is set to position (3) in the following chart. If selected in a cooling or dry operation, the flap is set at position (7) in the following chart.
-  : The airflow direction can be set manually. (six positions)
-  : The flap moves up and down automatically.

NOTE

When you press the FLAP button, the air flow direction will be changed one by one as follows.

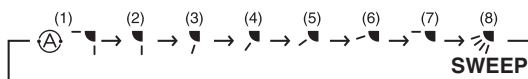





ON TIME/OFF TIME setting buttons

Advance button

Return button

No display: The timer does not operate.

-  : The air conditioner starts at the set time.
-  : The air conditioner stops at the set time.
-    : The air conditioner stops and starts, or starts and stops, at the set times every day. For details, see "SETTING THE TIMER".

CANCEL button

SENSOR button

When you press this button (use a small-tipped object such as a ballpoint pen), the  mark will appear at the display. And the room temperature is detected by the sensor which is built into the indoor unit and the air conditioner is controlled accordingly.

NOTE

If the remote controller is located near a heat source, such as a space heater or in direct sunlight, press the SENSOR button to switch to the sensor on the indoor unit.

ADDRESS switch

- The address switch changes to prevent mixing of signals from remote controller's when two air conditioners are installed next to each other. Normally, the address switch is set to A. For more information, please contact the dealer where you made the purchase.
- Normally, the tabs on the remote controller should not be bent.

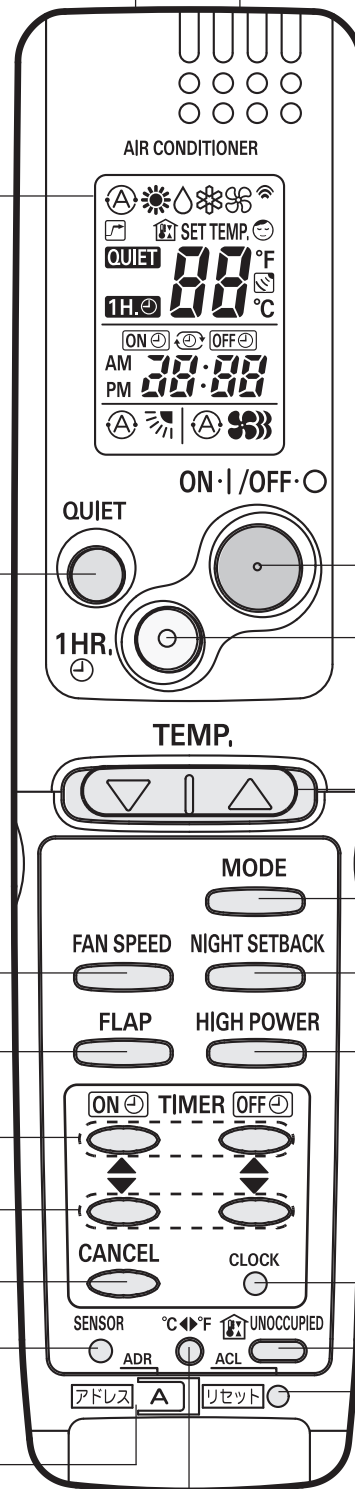

Temperature display selector button

This switches the temperature display between °C and °F.

Sensor

A temperature sensor inside the remote controller senses the room temperature.

ON/OFF operation button

This button is for turning the air conditioner on and off.

1 HR. TIMER button (1-HOUR OFF TIMER)

1H. ☺ : When you press this button, regardless of whether the unit is operating or stopping, the unit operates for one hour and then shuts down.

Temperature setting buttons (TEMP.)

Press the  button to increase the set temperature.

Press the  button to reduce the set temperature.

The temperature setting changes by 1 °C or 2 °F each time one of the TEMP. buttons is pressed.

MODE selector button

Use this button to select AUTO, HEAT, DRY, COOL or FAN mode.

(AUTO) Ⓐ : When this setting is selected, the air conditioner calculates the difference between the thermostat setting and the room temperature and automatically switches to the “COOL” or “HEAT” mode as appropriate.

(HEAT) ☀ : The air conditioner makes the room warmer.

(DRY) 💧 : The air conditioner reduces the humidity in the room.

(COOL) ❄ : The air conditioner makes the room cooler.

(FAN) 🌀 : The air conditioner works only as a circulation fan.

NIGHT SETBACK button

For details, see “5. Night Setback Mode”. When you press this button in the HEAT, DRY or COOL mode, the ☺ mark appears in the display, and the remote controller will automatically adjust the set temperature to save energy.

HIGH POWER button

 : If this button is pressed during HEAT, DRY, COOL or FAN operation, the unit operates at maximum output for 30 minutes, regardless of the desired temperature. The fan speed is 1step above “HIGH”.

CLOCK button

UNOCCUPIED button

For details, see “8. UNOCCUPIED Mode”. When you press this button, the 🏠 mark appears in the display. And the remote controller will automatically prevent the room temperature from decreasing too much (or increasing too much) when no one is in the room.

ACL button (ALL CLEAR)

Puts the remote controller into pre-operation status. Always press this button after replacing the batteries.

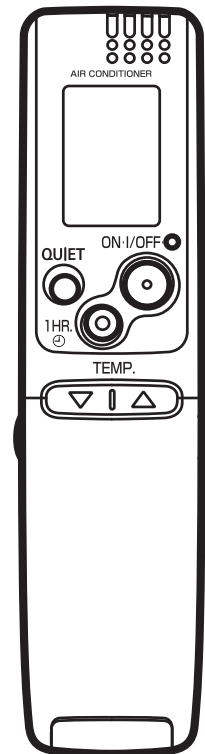

(Cover closed)

NOTE

- The illustration above pictures the remote controller after the cover has been opened.
- The remote controller sends the temperature signal to the air conditioner regularly at five minute intervals. If the signal from the remote controller stops for more than 15 minutes due to the loss of the remote controller or other trouble, the air conditioner will switch to the temperature sensor which is built into the indoor unit and control the room temperature. In these cases, the temperature around the remote controller may differ from the temperature detected at the air conditioner's position.
- The indoor fan runs continuously when the system is in normal operation. It does not turn off when the desired room temperature is reached. If Night Set Back mode is selected, the fan will turn off intermittently during cooling operation in order to control air flow.

USING THE REMOTE CONTROLLER

HOW TO INSTALL BATTERIES

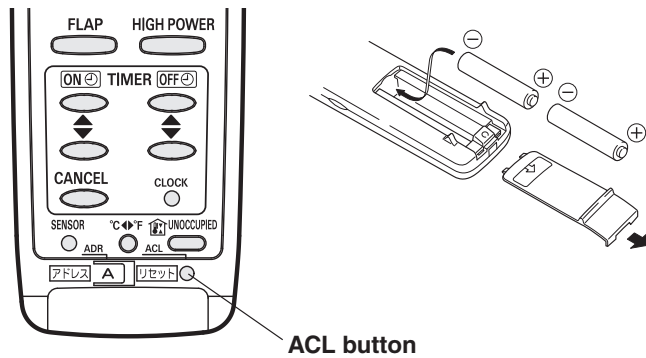

1. Slide the cover in the direction indicated by the arrow and remove it.
2. Install two AAA alkaline batteries. Make sure the batteries point in the direction marked in the battery compartment.
3. Use a thin object such as the tip of a pen to press the ACL button.



CAUTION

- The batteries last about six months, depending on how much you use the remote controller. Replace the batteries when the remote controller's display fails to light, or when the remote controller cannot be used to change the air conditioner's settings.
- Use two fresh leak-proof type-AAA alkaline batteries.
- In replacing batteries, follow the instructions as mentioned in the sub-section "HOW TO INSTALL BATTERIES".
- If you do not use the remote controller more than 1 month, take out the batteries.
- Dispose of the used batteries at the designated location in compliance with the applicable local ordinances.

Information for Users on Collection and Disposal of Old Equipment and used Batteries



[Information on Disposal in other Countries outside the European Union]

These symbols are only valid in the European Union. If you wish to discard these items, please contact your local authorities or dealer and ask for the correct method of disposal.



Note for the battery symbol (bottom two symbol examples):

This symbol might be used in combination with a chemical symbol. In this case it complies with the requirement set by the Directive for the chemical involved.

Pb

HOW TO USE THE REMOTE CONTROLLER

When using the remote controller, always point the unit's transmitter head directly at the air conditioner's receiver.

Air Conditioner (Indoor unit)

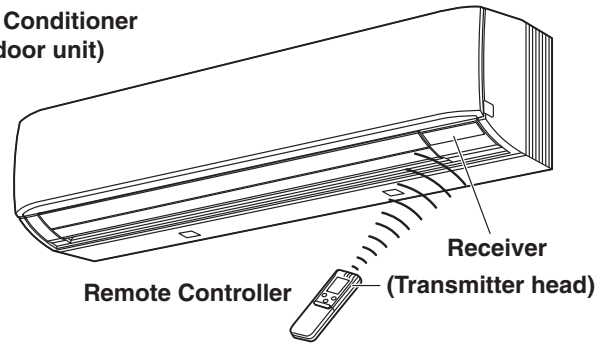

REMOTE CONTROLLER INSTALLATION POSITION

The remote controller may be operated either from a non-fixed position or from a wall-mounted position. To ensure that the air conditioner operates correctly, do not install the remote controller in the following places:

- In direct sunlight
- Behind a curtain or other places where it is covered
- More than 26 ft.(8 m) away from the air conditioner
- In the path of the air conditioner's airstream
- Where it may become extremely hot or cold
- Where it may be subject to electrical or magnetic noise
- Where there is an obstacle between the remote controller and air conditioner (since a check signal is sent from the remote controller every 5 minutes)

MOUNTING THE REMOTE CONTROLLER

Before mounting the remote controller, press the ON/OFF operation button at the mounting location to make sure that the air conditioner operates from that location. The indoor unit should make a beeping sound to indicate that it has received the signal.

Remote Control Holder

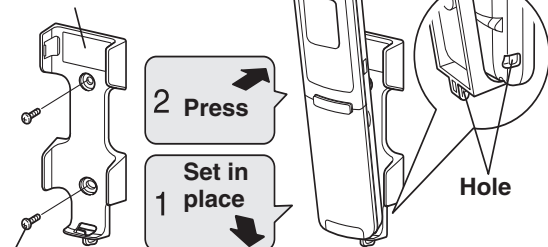

Mounting Screws
5/32 x 13/16"
(4 x 20 mm)
(included)

- To prevent loss of the remote controller, you can connect the remote controller to the holder by passing a string through the remote controller and attachment hole.

To take out the remote controller, pull it forward.

WHEN HOLDING THE REMOTE CONTROLLER

- When using the remote controller and during air conditioner operation, the transmitter on the remote controller should be pointed towards the receiver on the indoor unit.
- Make sure that there are no objects between the remote controller and receiver which could block the signal.

OPERATION WITH THE REMOTE CONTROLLER

1. Automatic Operation

This unit automatically switches between cooling operation and heating operation according to the difference between the room temperature and the temperature setting.

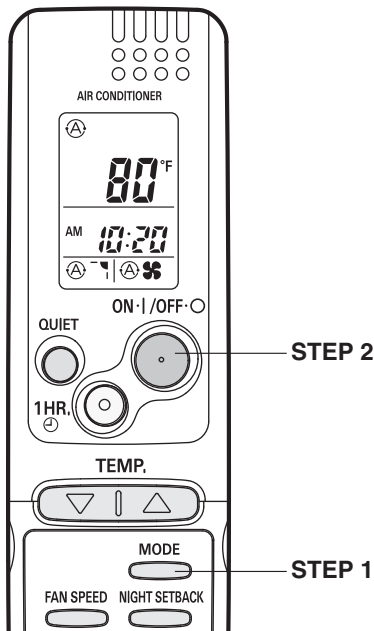

NOTE Check that the circuit breaker on the power panel is turned on.

Once (A) mode is selected and the unit is preset by following the steps below, you can have the air conditioner automatically bring the room to the desired temperature simply by pressing the ON/OFF operation button.

STEP 1	Press the MODE selector button to (A) .
STEP 2	Press the ON/OFF operation button.

To stop the air conditioner, press the ON/OFF operation button again.

NOTE • To change the temperature setting; press the temperature setting buttons and change the setting to the desired temperature.

2. Manual Operation

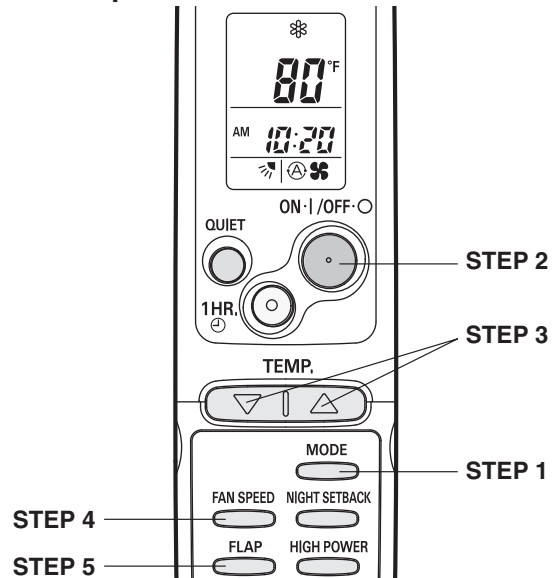

NOTE Check that the circuit breaker on the power panel is turned on.

If the automatic operation settings of the unit do not meet your needs, press the setting buttons as described below and change the settings as desired.

STEP 1	Press the MODE selector button and select the desired mode. For heating operation → ☀ For dehumidifying operation → 💧 For cooling operation → ❄️ For fan only operation → 🌀
STEP 2	To start the air conditioner, press the ON/OFF operation button.
STEP 3	Press the TEMP. setting buttons to change the temperature setting to the desired temperature. Adjustable temperature range: 30 °C max. or 86 °F max. 16 °C min. 60 °F min.
STEP 4	Set the FAN SPEED selector button to the setting you want.
STEP 5	Press the FLAP button and set the airflow direction as desired. (Refer to “ADJUSTING THE AIRFLOW DIRECTION” on page 15.)

To stop the air conditioner, press the ON/OFF operation button again.

NOTE • Choose the best position in the room for the remote controller, which also acts as the sensor for room comfort and transmits the operating instructions. Once you’ve found this best position, always keep the remote controller there.
• This appliance has a built-in 5-minute time delay circuit to ensure reliable operation. When the operation button is pressed, the compressor will start running within three minutes. In the event of power failure, the unit will stop.

3. Adjusting the Fan Speed

A. Automatic fan speed

Simply set the FAN SPEED selector button to the position.

This automatically sets the best fan speed for the room temperature.

B. Manual fan speed

If you want to adjust fan speed manually during operation, just set the FAN SPEED selector button as desired. [, , or]

4. Fan Only

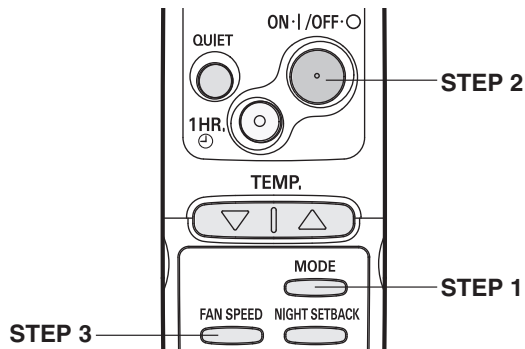

If you want to circulate air without any temperature control, follow these steps:

STEP 1	Press the MODE selector button to switch to the fan mode .
STEP 2	Press the ON/OFF operation button.
STEP 3	Press the FAN SPEED selector button to select the fan speed of your choice (, , or).

5. Night Setback Mode

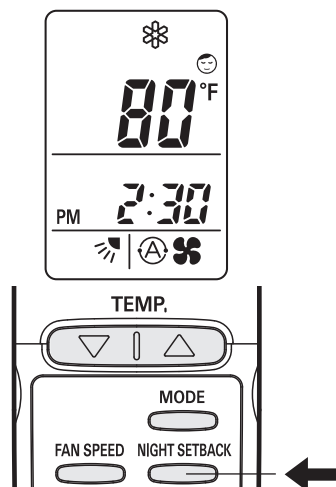

Night Setback Mode is used for saving energy.

Press the NIGHT SETBACK button while unit is operating. (except AUTO and FAN mode)
The mark appears in the display.

To release the night setback function, press the NIGHT SETBACK button again.

NOTE

Pressing the MODE selector button cancels Night Setback mode.

A. In Cooling and DRY Mode: (and)

When the night setback mode is selected, the air conditioner automatically raises the temperature setting 2 °F when 30 minutes have passed after the selection was made, and then another 2 °F after another 30 minutes have passed, regardless of the indoor temperature when night setback was selected. This enables you to save energy without sacrificing comfort. This function is convenient when gentle cooling is needed.

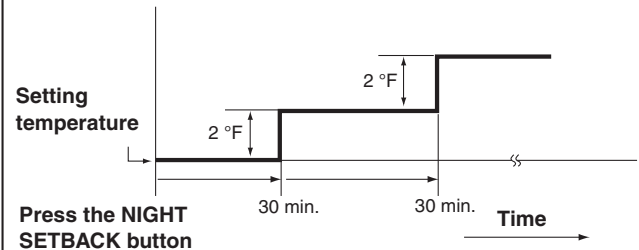

B. In Heating Mode: ()

When the night setback mode is selected, the air conditioner automatically lowers the temperature setting 4 °F when 30 minutes have passed after the selection was made, and then another 4 °F after another 30 minutes have passed, regardless of the indoor temperature when night setback was selected. This enables you to save energy without sacrificing comfort. This function is convenient when gentle heating is needed.

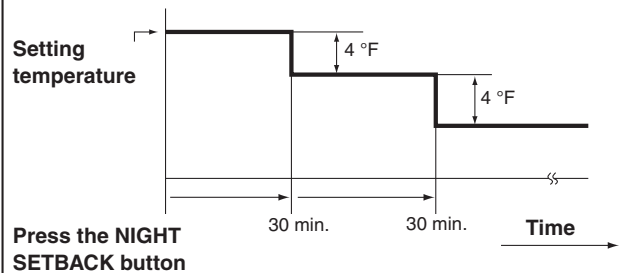

6. QUIET Mode

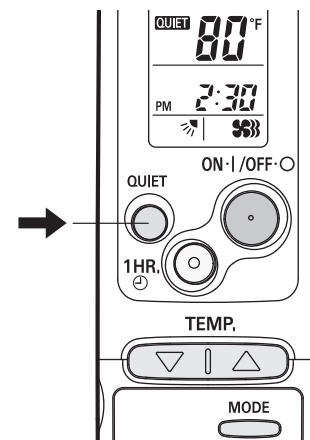

QUIET Mode is used to reduce the fan sound of the indoor unit.

Press the QUIET button.
The **QUIET** mark appears in the display.

To cancel, press QUIET button again.

- In QUIET Mode, the fan rotates at a slower speed than the fan speed setting.
- If the unit is already operating with a very low airflow, the fan sound may not change even if the QUIET button is pressed.

7. HIGH POWER Mode

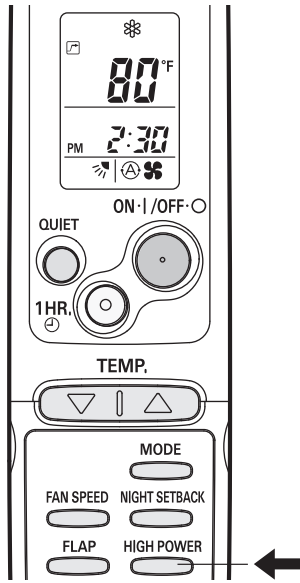

HIGH POWER mode can be used to increase the output of the indoor unit for all operation modes except automatic operation. Press the HIGH POWER button while unit is operating. The mark appears in the display.

To cancel, press HIGH POWER button again.

- When the HIGH POWER button is pressed, the unit operates at maximum output for 30 minutes, regardless of the desired temperature. The fan speed is 1 step above “High”.
- HIGH POWER Mode cannot be used when the operation mode is in Automatic Operation.
- QUIET Mode and HIGH POWER Mode cannot be used at the same time.

NOTE

- Pressing the MODE selector button cancels HIGH POWER mode.
- When set to High fan speed during heating operation, the fan runs at High fan speed even though the mark is displayed.
- Depending on the operating conditions, the fan speed may be increased by a small amount only.

8. UNOCCUPIED Mode

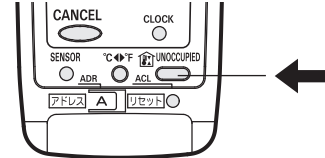
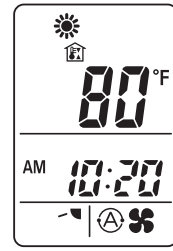

Unoccupied mode is used to prevent the room temperature from decreasing too much (or increasing too much) when no one is in the room, and operates automatically to save energy.

Press the UNOCCUPIED button.

The mark appears in the display.

To release the unoccupied function, press the UNOCCUPIED button again.

Unoccupied Indication

Unoccupied Function	Unoccupied Indication	Status
OFF	no display	The unoccupied function is not set.
ON	flashing	The unoccupied function is now being set, and under Heating (or Cooling) operation.
	lighting	Although the unoccupied function is set, not under Heating (or Cooling) operation.

NOTE

Even if Unoccupied Mode is ON, it will be disabled if the air conditioner is in operation.

- Unoccupied Function can be set and released through all operational modes, regardless of whether the air conditioner is operating or not.
- If the Unoccupied Function is ON and the remote controller is used to turn the air conditioner OFF (including OFF TIMER), the air conditioner will turn off, but depending on the room temperature, Heating or Cooling Operation will automatically begin.
- When the Unoccupied Function is in operation and the ON/OFF operation button is pressed, operation will restart based on the settings input before the air conditioner was turned off.

A. In Heating Mode: (☀)

- (1) When the room temperature drops below 46°F, Heating Operation will begin.
- (2) When the room temperature rises to above 53°F, Heating Operation will stop.

The above actions will repeat so that the room temperature is maintained at about 50°F.

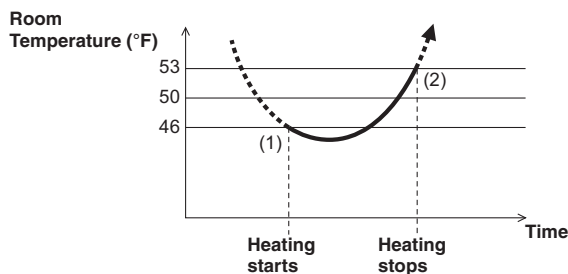

B. In Cooling Mode: (❄)

- (1) When the room temperature rises above 89°F, Cooling Operation will begin.
- (2) When the room temperature drops below 82°F, Cooling Operation will stop.

The above actions will repeat so that the room temperature is maintained at about 86°F.

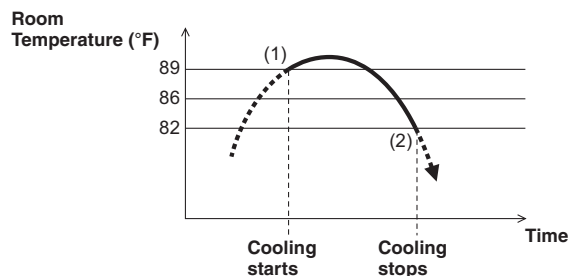

- Unoccupied Mode triggers Heating or Cooling Operation in response to the room temperature, but when this happens, the remote controller will continue to display the Operation mode set by the user.
- If the room temperature rapidly changes, the room temperature may get over the upper or lower limit when the unoccupied function is activated.

NOTE

- The remote controller should be used in the location specified in "REMOTE CONTROLLER INSTALLATION POSITION" on page 8.
- The air conditioner's stop order (stated in (2) / above) is valid only when the unoccupied function is operated.

SPECIAL REMARKS

"DRY" (💧) Operation

How it works?

- Once the room temperature reaches the level that was set, the unit's operation frequency is changed automatically.
- During DRY operation, the fan speed automatically runs at lower speed for providing a comfortable breeze.
- "DRY" operation is not possible if the indoor temperature is 59 °F or less.

Heating (☀) Operation

Heating performance

- When High power operation , Fan speed Automatic operation , HIGH or MEDIUM has been changed to Fan speed LOW , Quiet operation **QUIET** or Night Setback , the fan speed may not be reduced to the desired setting immediately but rather it may be reduced slowly in steps due to the operating status of the air conditioner. (A maximum of 5 minutes are required for the change to be completed.)
- Because this air conditioner heats a room by drawing in the heat of the outside air (heat pump system), the heating efficiency will fall off when the outdoor temperature is very low. If sufficient heat cannot be obtained with this air conditioner, use another heating appliance together with it.

Defrosting

- When the outdoor temperature is low, frost or ice may form on the heat exchanger coil, reducing heating performance. When this happens, a microcomputer defrosting system operates. At the same time, the fan on the indoor unit stops and the OPERATION lamp lights red and orange alternately until defrosting is completed. Heating operation restarts after several minutes. (This interval will vary slightly depending upon the outdoor temperature and the way in which frost forms.)

Cold draft prevention

- For several minutes after the start of heating operation, the indoor fan runs at a lower speed until the indoor heat exchanger coil has warmed up sufficiently. However, the fan may remain stopped when the room temperature is low. This is because the COLD DRAFT PREVENTION SYSTEM is in operation.

Cooling (❄) operation

- Sometimes the indoor unit may not get to the set fan speed such as LOW under cool operation at very low outdoor temperatures due to the indoor unit being protected from ice or frost.

Power failure during operation

- In the event of power failure, the unit will stop. When the power is resumed, the unit will restart automatically in approximately 5 minutes by the remote controller. If the remote controller is on and left in a location where the unit can receive a signal, then the unit will automatically restart in approximately 5 minutes of power being restored.

Clicking Sound

Clicking sound is heard from the air conditioner

- In heating or cooling operation, any plastic parts may expand or shrink due to a sudden temperature change. In this event, a clicking sound may occur. This is normal, and the sound will soon disappear.

Remote Controller

- The remote controller sends the setting condition to the air conditioner regularly at five minute intervals.

SETTING THE TIMER

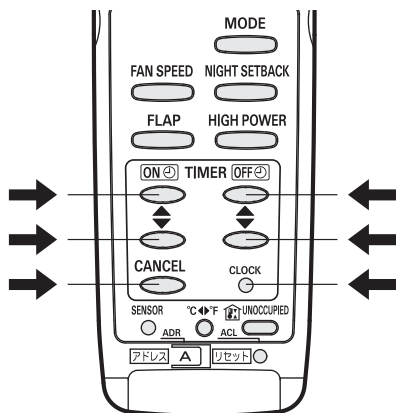

NOTE

In the descriptions below, the following settings are used for the temperature and time indicator selector button on the bottom front section of the remote controller.

- Temperature: °F
- Time: AM, PM

1. How to set the present time

(Example) To set to 10:30 pm.

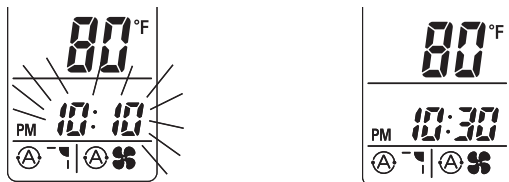

Operation	Indication
1. Press the CLOCK button once if the time indicator is not flashing.	The time indication alone flashes.
2. Press the Advance, Return (▲, ▼) button until PM 10:30 is displayed.	The time can be set in 1-minute increments. Holding down the button advances the time rapidly in 10-minute increments.
3. Press the CLOCK button again.	This completes the setting of the current time.

2. How to set the OFF time

(Example) To stop the air conditioner at 11:00 am.

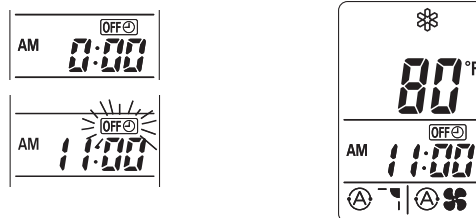

Operation	Indication
1. Press the OFF TIME setting button once.	The timer OFF TIME indication is displayed, and the present OFF time is shown.
2. Press the Advance, Return (▲, ▼) button until AM 11:00 is displayed.	The timer OFF TIME indication blinks. The time can be set in 10-minute increments. Holding down the button advances the time rapidly in 10-minute increments.
3. Wait a few seconds, and then the setting is complete.	The timer OFF TIME indication stops blinking and the present time is displayed.

3. How to set the ON time

(Example) To start operation at 7:10 am.

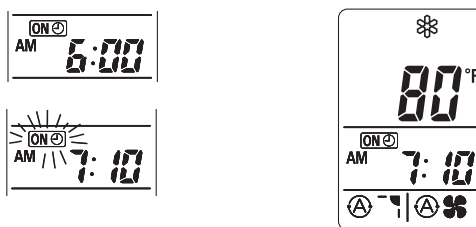



Operation	Indication
1. Press the ON TIME setting button once.	The timer ON TIME indication is displayed, and the present ON time is shown.
2. Press the Advance, Return (▲, ▼) button until AM 7:10 is displayed.	The timer ON TIME indication blinks. The time can be set in 10-minute increments. Holding down the button advances the time rapidly in 10-minute increments.
3. Wait a few seconds, and then the setting is complete.	The timer ON TIME indication stops blinking and the present time is displayed.

4. How to set daily ON/OFF repeat timer

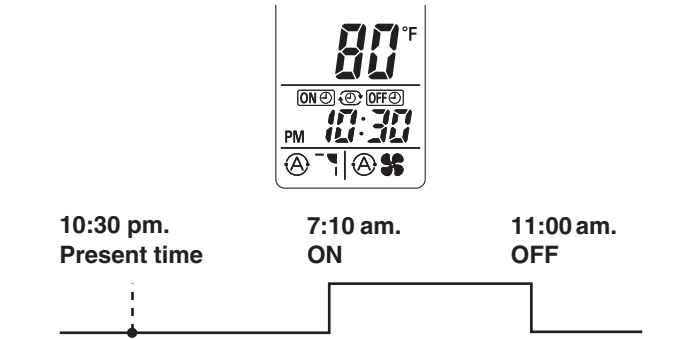
(Example) To start operation at 7:10 am. and stop the air conditioner at 11:00 am.



Operation	Indication
1. Set the timer ON/OFF times as shown in 2-1, 2, 3 and 3-1, 2, 3.	The present time 10:30 pm. and   are displayed.

NOTE

- The ON/OFF combination timer uses the current time as the reference, and it is activated starting from whichever set time comes first.
- With the ON/OFF combination timer, the settings are repeated every day.
- You can check the timer ON/OFF times after you have set them by pressing the ON TIME and OFF TIME setting buttons.

To cancel a timer program

- Press the CANCEL button.
- When either an ON or OFF timer is to be canceled, press the button corresponding to the timer whose program is to be canceled, and then press the CANCEL button.

NOTE

- The airflow direction, fan speed and temperature setting can be changed after a timer program has been set even when the unit is stopped. Even when operation is stopped during an ON timer program, the unit will start operating when the set time is reached provided that the program is not canceled.
- When the ON timer and OFF timer are set to the same time, the timer operates as if it is turned off.

USING THE 1-HOUR OFF TIMER

1. 1-Hour OFF Timer

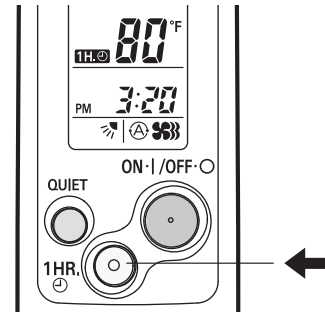

This function causes the unit to operate for one hour and then stop, regardless of whether the unit is on or off when this button is pressed.

The  indicator in the display indicates that this function is operating.

Setting procedure:

Regardless of whether the unit is operating or stopped, press the 1 HR. TIMER button.

 appears in the display.

Cancellation procedure:

Press the ON/OFF operation button to turn the unit off, wait for the unit to stop operating, and then press the ON/OFF operation button again.

The 1-Hour Timer function is now cancelled and the unit operates normally.

NOTE

- If, while the 1-Hour Timer function is operating, the 1HR. TIMER button is pressed once to cancel the function and then again, the unit continues to operate for one hour from that point in time and then stops.
- It is not possible to use the OFF Timer and 1-Hour OFF Timer together. Whichever function is set last takes precedence. If the 1 HR. TIMER button is pressed while the TIMER OFF function operates, the OFF Timer is cancelled and the unit will stop operating one hour later.

2. Operation together with the daily ON/OFF repeat timer

The 1-Hour OFF Timer setting is given priority over the DAILY ON/OFF REPEAT setting.

TIPS FOR ENERGY SAVING

Avoid

- Do not block neither the air intake nor the air outlet. It may cause less performance, and may leads to malfunctions.
- Do not let direct sunlight into the room. Use sunshades, blinds or curtains. If the walls and ceiling of the room are warmed by the sun, it will take longer to cool the room.

Do

- Always try to keep the air filter clean. (Refer to "CARE AND CLEANING".) A clogged filter will impair the performance of the unit.
- To prevent conditioned air from escaping, keep windows, doors and any other openings closed.

ADJUSTING THE AIRFLOW DIRECTION

1. Horizontal

The horizontal airflow can be adjusted by moving the vertical vanes with your hands to the left or right.

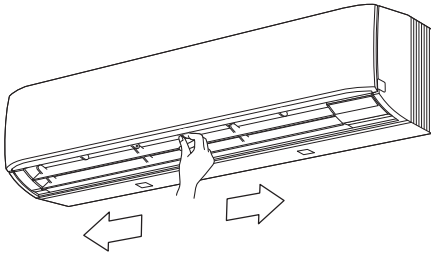

CAUTION

When the humidity is high, the vertical vanes should be in the front position during the cooling or dehumidifying operation. If the vertical vanes are positioned all of the way to the right or left, condensation may begin to form around the air vent and drip down.

2. Vertical

The vertical airflow can be adjusted by moving the flap with the remote controller. Do not move the flap with your hands. Confirm that the remote controller has been turned on. Use the FLAP button to set either the sweep function or one of the six airflow direction settings.

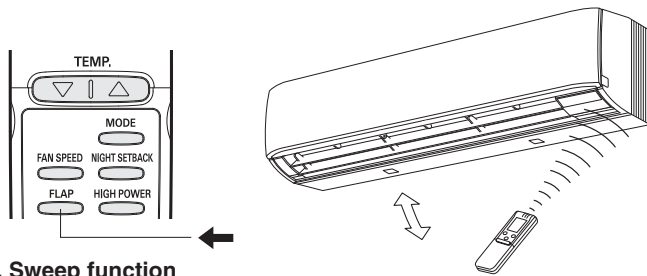

A. Sweep function



The flap starts moving up and down to deliver air over the sweep range.

B. Setting the airflow manually



Referring to the above illustration, use the FLAP button to set the airflow direction within the range used during the heating, cooling, or dehumidifying operation.

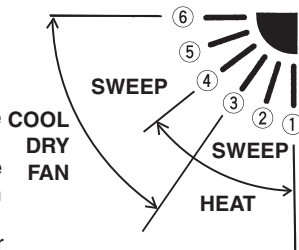

C. Auto flap function



The flap is set to the recommended position.

NOTE

- The flap automatically closes when the unit is off.
- During the heating operation, the fan speed will be very low and the flap will be in the horizontal position (position ⑥) until the air being blown out of the unit begins to warm. Once the air warms up, the flap position and fan speed change to the settings specified with the remote controller.



CAUTION

- Use the FLAP button on the remote controller to adjust the position of the flap. If you move the flap by hand, the flap position according to the remote controller and the actual flap position may no longer match. If this should happen, shut off the unit, wait for the flap to close, and then turn on the unit again; the flap position will now be normal again.
- Do not have the flap pointed down during cooling operation. Condensation may begin to form around the air vent and drip down.

OPERATION WITHOUT THE REMOTE CONTROLLER

INDOOR UNIT

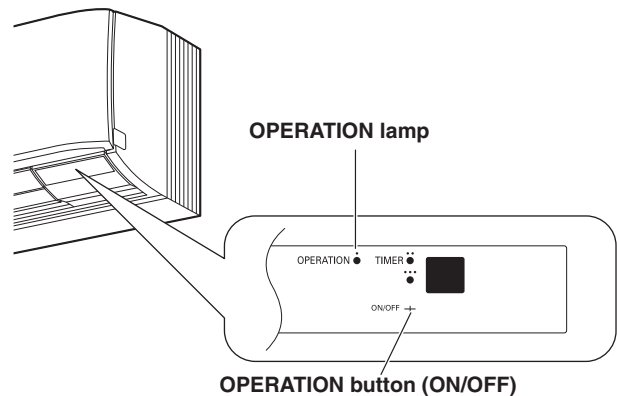

If you have lost the remote controller or it has trouble, follow the steps below.

When the air conditioner is not running

Each time the OPERATION button is pressed, the type of operation conducted is indicated by the changing color of the OPERATION lamp. Press the button and select the lamp color that suits your preference for operation.

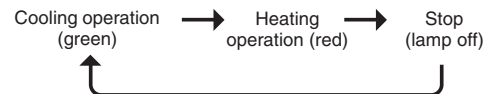

NOTE

The temperature is set to the room temperature minus 4°F during the cooling operation and to the room temperature plus 4°F during the heating operation, and the fan speed and flap are set to Auto.

CARE AND CLEANING



WARNING

1. For safety, be sure to turn the air conditioner off and also to disconnect the power before cleaning.
2. Do not pour water on the indoor unit to clean it. This will damage the internal components and cause an electric shock hazard.

Casing and Grille (Indoor Unit)

Clean the casing and grille of the indoor unit with a vacuum cleaner brush, or wipe them with a clean, soft cloth.

If these parts are stained, use a clean cloth moistened with a mild liquid detergent. When cleaning the grille, be careful not to force the vanes out of place.



CAUTION

1. Never use solvents, or harsh chemicals when cleaning the indoor unit. Do not wipe the plastic casing using very hot water.
2. Some metal edges and the fins are sharp and may cause injury if handled improperly; be especially careful when you clean these parts.
3. The internal coil and other components of the outdoor unit must be cleaned every year. Consult your dealer or service center.

Filter

The filter behind the front panel should be checked and cleaned at least once every two weeks.

How to remove the filter

1. Grasp both ends of the front panel and pull forward and up to open the front panel.

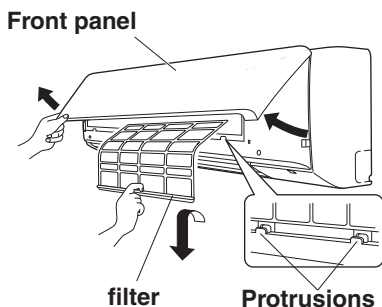

2. Lift the filter up slightly to disengage it from the protrusions on the unit.
3. Pull downward to remove the filter from the unit.

Cleaning

Use a vacuum cleaner to remove light dust. If there is sticky dust on the filter, wash the filter in lukewarm, soapy water, rinse it in clean water, and dry it.

How to replace the filter

1. Insert the top of the filter, and then secure the bottom of the filter with the protrusions on the unit.
2. Close the front panel by pushing the center of the front panel and then pressing both edges until the panel clicks into place.

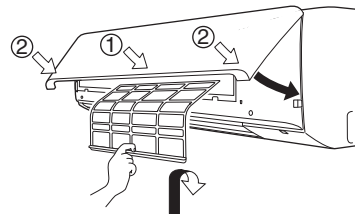

Cleaning the main unit and Remote Controller

- Wipe clean using a soft, dry cloth.
- To remove stubborn dirt, moisten a cloth in warm water no hotter than 104 °F, wring thoroughly, and then wipe.
- The front panel can be removed in order to wash it with water.

Removing and remounting the front panel

Removing

Open the front panel until it is nearly horizontal, grasp the sections near the front panel arms on both sides, and then remove the panel by pushing the arms towards the outside while pulling the panel towards you.

If the front panel is difficult to remove, grasp both ends of it and lift it up slightly.

Move it to the left and disengage the left arm, then move it to the right and disengage the right arm.

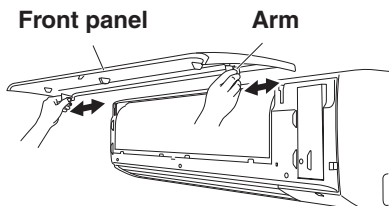

Remounting

Grasp the sections near the front panel arms on both sides, and hold the front panel so that it is nearly horizontal. Push the arm shafts towards the outside so that they come into contact with the top of the indentations on the right and left sides of the air conditioner. Then push firmly until the arm shafts click into place. After closing the front panel, press firmly on the parts indicated by the arrows to securely fasten the panel in place. Also refer to the figure that shows "How to replace the filter".



CAUTION

When using a footstool or the like, be careful not to let it tip over.

Washing the front panel with water

- Clean the front panel gently using a soft sponge, or the like. Then wipe away any remaining moisture.
- Neutral detergent may be used to remove stubborn dirt. Then rinse thoroughly with water and wipe away any remaining moisture.

TROUBLESHOOTING (BEFORE CALLING FOR SERVICE)

If your air conditioner does not work properly, first check the following points before requesting service. If it still does not work properly, contact your dealer or service center.

Trouble	Possible Cause	Remedy
Air conditioner does not run at all.	<ol style="list-style-type: none"> 1. Power failure. 2. Leakage circuit breaker tripped. 3. Line voltage is too low. 4. Batteries in remote controller have run down. 	<ol style="list-style-type: none"> 1. Restore power. 2. Contact service center. 3. Consult your electrician or dealer. 4. Replace batteries.
OPERATION lamp blinks and air conditioner does not operate.	Trouble in system.	Contact service center.
Compressor runs but soon stops.	Obstruction in front of condenser coil. (Outdoor Unit)	Remove obstruction.
Poor cooling (or heating) performance.	<ol style="list-style-type: none"> 1. Dirty or clogged air filter. 2. Heat source or many people in room. 3. Doors and/or windows are open. 4. Obstacle near air intake or air discharge port. 5. Thermostat is set too high for cooling (or too low for heating). 6. (Outdoor temperature is too low for heating.) 	<ol style="list-style-type: none"> 1. Clean air filter to improve airflow. 2. Eliminate heat source if possible. 3. Shut them to keep the heat (or cold) out. 4. Remove it to ensure good airflow. 5. Set the temperature lower (or higher). 6. (Consult your dealer or try to use another heat appliance.)
Clicking sound is heard from the air conditioner.	In heating or cooling operation, any plastic parts may expand or shrink due to a sudden temperature change. In this event, a clicking sound may occur.	This is normal, and the sound will soon disappear.
OPERATION lamp lights but outdoor unit will not run.	The use of cellular phones near the air conditioner may cause disturbance to its normal operation.	<ol style="list-style-type: none"> 1. Turn off the power then restart the air conditioner after a while. 2. Consult your dealer.

OPERATING RANGE

The air conditioner is operable within the temperature ranges as listed below:

	Temperature	Indoor air temperature	Outdoor air temperature
COOLING	Max.	95 °F DB / 71 °F WB	115 °F DB
	Min.	67 °F DB / 57 °F WB	0 °F DB
HEATING	Max.	80 °F DB / 67 °F WB	75 °F DB / 65 °F WB
	Min.	- DB / - WB	- DB / 0 °F WB

WIRED REMOTE CONTROLLER

A separately sold wired remote controller (CZ-RD515U) used with this air conditioner is also available. If you wish to use the wired remote control function, you will need to purchase both the optional wired remote controller and its connection kit (CZ-RC515UA).

EG

SPECIFICATIONS

Model No.			Outdoor Unit		Indoor Unit	
			CU-KE30NKU		CS-KE30NKU	
Power Source			Single-phase, 208-230 V, 60 Hz			
Cooling Capacity			kW	9.00 [3.20 ~ 9.00]		
			BTU/h	30,600 [10,900 ~ 30,600]		
Heating Capacity			kW	9.70 [4.10~9.70]		
			BTU/h	33,000 [14,000~33,000]		
Operation Sound	Cooling Operation	Outdoor (Hi)	dB(A)	55		
		Indoor(H/M/L)		-		
	Heating Operation	Outdoor (Hi)	dB(A)	55		
		Indoor(H/M/L)		-		
Unit Dimensions (HxWxD) (Indoor unit : Include panel)		inch(mm)	35-13/16x37-1/32x13-3/8 (910x940x340)		11-13/16x41-15/16x9-1/16 (300x1065x230)	
Net Weight		lbs.(kg)	185.2(84.0)		32.0(14.5)	

Model No.			Outdoor Unit		Indoor Unit	
			CU-KE36NKU		CS-KE36NKU	
Power Source			Single-phase, 208-230 V, 60 Hz			
Cooling Capacity			kW	10.00 [3.20 ~ 10.00]		
			BTU/h	34,000 [10,900 ~ 34,000]		
Heating Capacity			kW	10.50 [4.10~10.50]		
			BTU/h	36,000 [14,000~36,000]		
Operation Sound	Cooling Operation	Outdoor (Hi)	dB(A)	55		
		Indoor(H/M/L)		-		
	Heating Operation	Outdoor (Hi)	dB(A)	55		
		Indoor(H/M/L)		-		
Unit Dimensions (HxWxD) (Indoor unit : Include panel)		inch(mm)	35-13/16x37-1/32x13-3/8 (910x940x340)		11-13/16x41-15/16x9-1/16 (300x1065x230)	
Net Weight		lbs.(kg)	185.2(84.0)		32.0(14.5)	

