

Panasonic®

Operating Instructions INTERCHANGEABLE LENS FOR DIGITAL CAMERA

Model No. **H-X025**

LUMIX

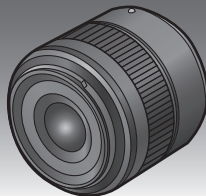

Before connecting, operating or adjusting this product, please read the instructions completely.



LEICA
DG SUMMILUX



If you have any questions, visit:
USA : <http://shop.panasonic.com/support>
Canada : www.panasonic.ca/english/support

PP

VQT3N27-3

Contents

Information for Your Safety	2
Precautions	5
Supplied Accessories	6
Attaching/Detaching the Lens	6
Names and Functions of Components	8
Cautions for Use	9
Troubleshooting	10
Specifications	11
Limited Warranty	12

-If you see this symbol-

Information on Disposal in other Countries outside the European Union



This symbol is only valid in the European Union.

If you wish to discard this product, please contact your local authorities or dealer and ask for the correct method of disposal.



THE FOLLOWING APPLIES ONLY IN CANADA.

This Class B digital apparatus complies with Canadian ICES-003.

Information for Your Safety

Keep the unit as far away as possible from electromagnetic equipment (such as microwave ovens, TVs, video games, radio transmitters, high-voltage lines etc.).

- Do not use the camera near cell phones because doing so may result in noise adversely affecting the pictures and sound.
- If the camera is adversely affected by electromagnetic equipment and stops functioning properly, turn the camera off and remove the battery and/or the connected AC adaptor. Then reinsert the battery and/or reconnect the AC adaptor and turn the camera on.

The lens can be used with a digital camera compatible with the lens mount standard for the “Micro Four Thirds™ System”.

- It cannot be mounted on the Four Thirds™ mount specification camera.
- The digital camera illustrations in these operating instructions show DMC-G3 as an example.
- The appearance and specifications of products described in this manual may differ from the actual products you have purchased due to later enhancements.
- Micro Four Thirds™ and Micro Four Thirds Logo marks are trademarks or registered trademarks of Olympus Corporation, in Japan, the United States, the European Union and other countries.
- Four Thirds™ and Four Thirds Logo marks are trademarks or registered trademarks of Olympus Corporation, in Japan, the United States, the European Union and other countries.
- G MICRO SYSTEM is a lens exchange type digital camera system of LUMIX based on a Micro Four Thirds System standard.

- LEICA is a registered trademark of Leica Microsystems IR GmbH. SUMMILUX is a registered trademark of Leica Camera AG. The LEICA DG lenses are manufactured using measurement instruments and quality assurance systems that have been certified by Leica Camera AG based on the company's quality standards.
- Other names of systems and products mentioned in these instructions are usually the registered trademarks or trademarks of the manufacturers who developed the system or product concerned.

THE FOLLOWING APPLIES ONLY IN THE U.S.A.

FCC Note:

This equipment has been tested and found to comply with the limits for a Class B digital device, pursuant to Part 15 of the FCC Rules.

These limits are designed to provide reasonable protection against harmful interference in a residential installation. This equipment generates, uses and can radiate radio frequency energy and, if not installed and used in accordance with the instructions, may cause harmful interference to radio communications. However, there is no guarantee that interference will not occur in a particular installation. If this equipment does cause harmful interference to radio or television reception, which can be determined by turning the equipment off and on, the user is encouraged to try to correct the interference by one or more of the following measures:

- Reorient or relocate the receiving antenna.
- Increase the separation between the equipment and receiver.
- Connect the equipment into an outlet on a circuit different from that to which the receiver is connected.
- Consult the dealer or an experienced radio/TV technician for help.

Any unauthorized changes or modifications to this equipment would void the user's authority to operate this device.

This device complies with Part 15 of the FCC Rules. Operation is subject to the following two conditions: (1) This device may not cause harmful interference, and (2) this device must accept any interference received, including interference that may cause undesired operation.

Responsible Party:

Panasonic Corporation of North America

Two Riverfront Plaza, Newark, NJ 07102-5490

Support Contact: <http://www.panasonic.com/contactinfo>

■ Lens Care

- **Sand and dust can damage the lens. Make sure that no sand or dust gets inside the lens or the terminals when using the lens on a beach, etc.**
- **This lens is not waterproof. If drops of water get onto the lens, wipe the lens with a dry cloth.**
- Do not press the lens with excessive force.
- When there is dirt (water, oil, and fingerprints, etc.) on the surface of the lens, the picture may be affected. Lightly wipe the surface of the lens with a soft, dry cloth before and after taking pictures.
- Do not place the lens mount facing downwards. Do not allow the lens contact points ① to become dirty.

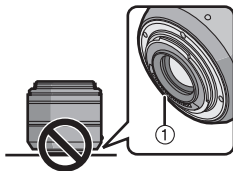

■ About Condensation (Fogging of the Lens)

- Condensation occurs when there are differences in temperature and humidity as described below. Condensation can cause the lens to become dirty and lead to mold and malfunctioning, so exercise caution in the following situations:
 - When the camera is brought indoors from outside during cold weather
 - When the camera is brought into an air-conditioned car
 - When cold air from an air conditioner is directly blown onto the lens
 - In humid places
- Put the camera into a plastic bag to allow it to acclimatize to the surrounding temperature in order to prevent condensation. If condensation occurs, turn the power off and leave it for about two hours. Once the camera acclimatizes to the surrounding temperature the condensation will go away naturally.

Supplied Accessories

[Inspection to be performed when you unpack the unit]

When removing the unit from its packing box, check that the main unit and the supplied accessories are there and also check their external appearance and functions to verify that they have not sustained any damage during distribution and transportation. If you discover any trouble, contact your vendor before using the product.

Product numbers correct as of July 2011. These may be subject to change.

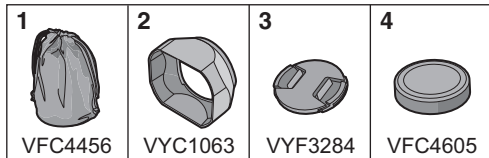

- 1** Lens Storage Bag
- 2** Lens Hood
- 3** Lens Cap
- 4** Lens Rear Cap
(The lens rear cap and lens cap are attached to the interchangeable lens at the time of purchase.)

6

VQT3N27

Attaching/Detaching the Lens

- Refer also to the camera's operating instructions for attaching and detaching the lens.

■ Attaching the Lens

- Check that the camera is turned off.

1 Turn the lens rear cap to detach it.

(A): Lens Rear Cap

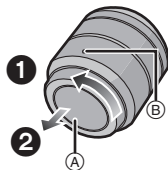

2 Align the lens fitting marks (B) (red marks) on the camera body and the lens and then rotate the lens in the direction of the arrow until it clicks.

- Do not press the lens release button (C) when you attach a lens.
- Do not try to attach the lens when holding it at an angle to the camera body as the lens mount may get scratched.
- Check that the lens is attached correctly.



■ Detaching the Lens

- Check that the camera is turned off.

While pressing on the lens release button **(D)**, rotate the lens toward the arrow until it stops and then remove.

- Attach the lens rear cap so that the lens contact point does not get scratched.
- Attach the body cap to the camera so no dirt or dust will get inside the main unit.



■ Attaching and Detaching the Lens Cap Pinch the lens cap as shown in the figure to attach or detach.

- Be careful not to lose the lens cap.

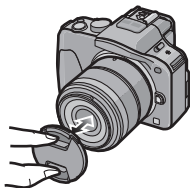

■ Attaching the Lens Hood (Supplied Accessory)

Insert the lens hood into the lens with the short sides at the top and bottom, and turn in the direction of the arrow until it stops.

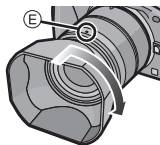

(E): Fit to the mark

- When taking pictures with the flash with the lens hood attached, the lower portion of the screen may turn dark (vignetting effect) and the control of the flash may be disabled because the photo flash may be obscured by the lens hood. We recommend detaching the lens hood.
- When using the AF assist lamp in the dark, detach the lens hood.

■ Attaching Filters

- Vignetting may occur if using 2 or more MC protectors (optional: DMW-LMC46), PL filters (optional: DMW-LPL46) or ND filters (optional: DMW-LND46), or if using thick protectors and/or filters.
- The filter may become impossible to remove if excessively tightened, so please refrain from tightening it too strongly.
- It is possible to attach the lens cap with the filter already attached.
- You cannot attach a conversion lens or adaptor to this lens. A filter may be used, but attaching any other element may cause damage to the lens.

Names and Functions of Components

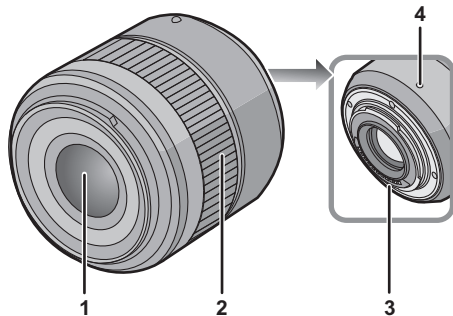

- 1 Lens surface
- 2 Focus ring
Rotate to focus when taking pictures with manual focus.
- 3 Contact points
- 4 Lens fitting mark



Note

- Change in the image by the focus operation may be more visible depending on the recording condition when the AF operates during the motion picture recording. It is recommended to fix the focus by setting the camera to manual focus (MF), etc., when the change of image is disturbing you.

Cautions for Use

Take care not to drop or knock the lens. Also take care not to put a lot of pressure on the lens.

- Take care not to drop the bag that you inserted the lens in as it may damage the lens. The camera may stop operating normally and pictures may no longer be recorded.

When using pesticides and other volatile substances around the camera make sure that they do not get onto the lens.

- If such substances get onto the lens they can damage the exterior case or cause the paint to peel.

Do not carry the unit when it is still attached to the camera body.

- Under no circumstances should the unit be stored in any of the following locations since doing so may cause problems in operation or malfunctioning.
 - In direct sunlight or on a beach in summer
 - In locations with high temperatures and humidity levels or where the changes in temperature and humidity are acute

- In locations with high concentrations of sand, dust or dirt
- Where there is fire
- Near heaters, air conditioners or humidifiers
- Where water may make the unit wet
- Where there is vibration
- Inside a vehicle
- Refer also to the operating instructions of the digital camera.
- When the unit is not going to be used for a prolonged period, we recommend storing with a desiccant (silica gel). Failure to do so may result in performance failure caused by mold, etc. It is recommended that you check the unit's operation prior to use.
- Do not leave the lens in contact with rubber or plastic products for extended periods of time.
- Do not touch the lens contact point. Doing so can cause failure of the unit.
- Do not disassemble or alter the unit.

Do not use benzine, thinner, alcohol or other similar cleaning agents to clean the lens glass or exterior cabinet.

- Using solvents can damage the lens or cause the paint to peel.
- Wipe off any dust or fingerprints with a soft, dry cloth.
- Use a dry dust cloth to remove dirt and dust on the focus ring.
- Do not use a household detergent or a chemically treated cloth.

Troubleshooting

A sound is heard when the camera is turned on or off.

A sound is heard from the lens when taking a picture of a bright subject such as when outdoors.

- This is the sound of lens or aperture movement and is not a malfunction.

Specifications

INTERCHANGEABLE LENS FOR DIGITAL CAMERA

“LEICA DG SUMMILUX 25 mm/F1.4 ASPH.”

Focal length	f=25 mm (35 mm film camera equivalent: 50 mm)
Aperture type	7 diaphragm blades/circular aperture diaphragm
Aperture range	F1.4
Minimum aperture value	F16
Lens construction	9 elements in 7 groups (2 aspherical lenses)
In focus distance	0.3 m (0.99 feet) to ∞ (from the focus distance reference line)
Maximum image magnification	0.11 \times (35 mm film camera equivalent: 0.22 \times)
Optical image stabilizer	Not available
Mount	“Micro Four Thirds Mount”
Angle of view	47°
Filter diameter	46 mm (1.81 inch)
Max. diameter	Approx. 63 mm (2.48 inch)
Overall length	Approx. 54.5 mm (2.15 inch) (from the tip of the lens to the base side of the lens mount)
Mass (Weight)	Approx. 200 g (0.44 lb)

Limited Warranty

ONLY FOR U.S.A.

Panasonic Products Limited Warranty

Limited Warranty Coverage (For USA Only)

If your product does not work properly because of a defect in materials or workmanship, Panasonic Corporation of North America (referred to as “the warrantor”) will, for the length of the period indicated on the chart below, which starts with the date of original purchase (“warranty period”), at its option either (a) repair your product with new or refurbished parts, (b) replace it with a new or a refurbished equivalent value product, or (c) refund your purchase price. The decision to repair, replace or refund will be made by the warrantor.

Product or part name	Parts	Labor
Interchangeable Lens for Digital Camera	1 Year	1 Year
All included Accessories (Except Non-Rechargeable Batteries)	90 Days	Not Applicable
Only Non-Rechargeable Batteries	10 Days	Not Applicable

During the “Labor” warranty period there will be no charge for labor. During the “Parts” warranty period, there will be no charge for parts. This Limited Warranty excludes both parts and labor for non-rechargeable batteries, antennas, and cosmetic parts (cabinet). This warranty only applies to products purchased and serviced in the United States. This warranty is extended only to the original purchaser of a new product which was not sold “as is”.

Mail-In Service--Online Repair Request

Online Repair Request

To submit a new repair request and for quick repair status visit our Web Site at <http://shop.panasonic.com/support>.

When shipping the unit, carefully pack, include all supplied accessories listed in the Owner's Manual, and send it prepaid, adequately insured and packed well in a carton box. When shipping Lithium Ion batteries please visit our Web Site at <http://shop.panasonic.com/support> as Panasonic is committed to providing the most up to date information. Include a letter detailing the complaint, a return address and provide a daytime phone number where you can be reached. A valid registered receipt is required under the Limited Warranty.

IF REPAIR IS NEEDED DURING THE WARRANTY PERIOD, THE PURCHASER WILL BE REQUIRED TO FURNISH A SALES RECEIPT/PROOF OF PURCHASE INDICATING DATE OF PURCHASE, AMOUNT PAID AND PLACE OF PURCHASE. CUSTOMER WILL BE CHARGED FOR THE REPAIR OF ANY UNIT RECEIVED WITHOUT SUCH PROOF OF PURCHASE.

Limited Warranty Limits and Exclusions

This warranty ONLY COVERS failures due to defects in materials or workmanship, and DOES NOT COVER normal wear and tear or cosmetic damage. The warranty ALSO DOES NOT COVER damages which occurred in shipment, or failures which are caused by products not supplied by the warrantor, or failures which result from accidents, misuse, abuse, neglect, mishandling, misapplication, alteration, faulty installation, set-up adjustments, misadjustment of consumer controls, improper maintenance, power line surge, lightning damage, modification, introduction of sand, humidity or liquids, commercial use such as hotel, office, restaurant, or other business or rental use of the product, or service by anyone other than a Factory Service Center or other Authorized Servicer, or damage that is attributable to acts of God.

THERE ARE NO EXPRESS WARRANTIES EXCEPT AS LISTED UNDER "LIMITED WARRANTY COVERAGE". THE WARRANTOR IS NOT LIABLE FOR INCIDENTAL OR CONSEQUENTIAL DAMAGES RESULTING FROM THE USE OF THIS PRODUCT, OR ARISING OUT OF ANY BREACH OF THIS WARRANTY.

(As examples, this excludes damages for lost time, travel to and from the servicer, loss of or damage to media or images, data or other memory or recorded content. The items listed are not exclusive, but for illustration only.)

ALL EXPRESS AND IMPLIED WARRANTIES, INCLUDING THE WARRANTY OF MERCHANTABILITY, ARE LIMITED TO THE PERIOD OF THE LIMITED WARRANTY.

Some states do not allow the exclusion or limitation of incidental or consequential damages, or limitations on how long an implied warranty lasts, so the exclusions may not apply to you.

This warranty gives you specific legal rights and you may also have other rights which vary from state to state. If a problem with this product develops during or after the warranty period, you may contact your dealer or Service Center. If the problem is not handled to your satisfaction, then write to:

Consumer Affairs Department
Panasonic Corporation of North America
661 Independence Pkwy
Chesapeake, VA 23320

PARTS AND SERVICE, WHICH ARE NOT COVERED BY THIS LIMITED WARRANTY, ARE YOUR RESPONSIBILITY.

Shop
Accessories!

for all your Panasonic gear

Go to

<http://shop.panasonic.com/support>

Get everything you need to get the most out of
your Panasonic products

Accessories & Parts for your Camera, Phone, A/V
products, TV, Computers & Networking, Personal
Care, Home Appliances, Headphones, Batteries,
Backup Chargers & more...

Customer Services Directory

For Product Information, Operating Assistance,
Parts, Owner's Manuals, Dealer and Service info
go to <http://shop.panasonic.com/support>

For the hearing or speech impaired TTY: 1- 877-833-8855

As of July 2015

FOR CANADA

Panasonic Canada Inc.

5770 Ambler Drive, Mississauga, Ontario L4W 2T3

PANASONIC PRODUCT – LIMITED WARRANTY

Panasonic Canada Inc. warrants this product to be free from defects in material and workmanship under normal use and for a period as stated below from the date of original purchase agrees to, at its option either (a) repair your product with new or refurbished parts, (b) replace it with a new or a refurbished equivalent value product, or (c) refund your purchase price. The decision to repair, replace or refund will be made by Panasonic Canada Inc.

Interchangeable Lens for Digital Camera	One (1) year, parts and labour
--	---------------------------------------

This warranty is given only to the original purchaser, or the person for whom it was purchased as a gift, of a Panasonic brand product mentioned above sold by an authorized Panasonic dealer in Canada and purchased and used in Canada, which product was not sold "as is", and which product was delivered to you in new condition in the original packaging.

IN ORDER TO BE ELIGIBLE TO RECEIVE WARRANTY SERVICE HEREUNDER, A PURCHASE RECEIPT OR OTHER PROOF OF DATE OF ORIGINAL PURCHASE, SHOWING AMOUNT PAID AND PLACE OF PURCHASE IS REQUIRED

LIMITATIONS AND EXCLUSIONS

This warranty ONLY COVERS failures due to defects in materials or workmanship, and DOES NOT COVER normal wear and tear or cosmetic damage. The warranty ALSO DOES NOT COVER damages which occurred in shipment, or failures which are caused by products not supplied by Panasonic Canada Inc., or failures which result from accidents, misuse, abuse, neglect, mishandling, misapplication, alteration, faulty installation, set-up adjustments, misadjustment of consumer controls, improper maintenance,

improper batteries, power line surge, lightning damage, modification, introduction of sand, humidity or liquids, commercial use such as hotel, office, restaurant, or other business or rental use of the product, or service by anyone other than a Authorized Servicer, or damage that is attributable to acts of God.

Dry cell batteries, printer ink cartridge and paper are also excluded from coverage under this warranty.

Rechargeable batteries are warranted for ninety (90) days from date of original purchase.

THIS EXPRESS, LIMITED WARRANTY IS IN LIEU OF ALL OTHER WARRANTIES, EXPRESS OR IMPLIED, INCLUDING ANY IMPLIED WARRANTIES OF MERCHANTABILITY AND FITNESS FOR A PARTICULAR PURPOSE. IN NO EVENT WILL PANASONIC CANADA INC. BE LIABLE FOR ANY SPECIAL, INDIRECT OR CONSEQUENTIAL DAMAGES RESULTING FROM THE USE OF THIS PRODUCT OR ARISING OUT OF ANY BREACH OF ANY EXPRESS OR IMPLIED WARRANTY. (As examples, this warranty excludes damages for lost time, travel to and from the Authorized Servicer, loss of or damage to media or images, data or other memory or recorded content. This list of items is not exhaustive, but for illustration only.)

In certain instances, some jurisdictions do not allow the exclusion or limitation of incidental or consequential damages, or the exclusion of implied warranties, so the above limitations and exclusions may not be applicable. This warranty gives you specific legal rights and you may have other rights which vary depending on your province or territory.

WARRANTY SERVICE

For product operation, repairs and information assistance, please visit our Support page:

www.panasonic.ca/english/support

Índice

Información para su seguridad	16
Prevención contra las averías	19
Accesorios suministrados	20
Unir y quitar el objetivo	20
Nombres y funciones de los componentes	22
Precauciones para el uso	23
Búsqueda de averías	24
Especificaciones	25

-Si ve este símbolo-

Información sobre la eliminación en otros países no pertenecientes a la Unión Europea



Este símbolo sólo es válido en la Unión Europea. Si desea desechar este producto, póngase en contacto con las autoridades locales o con su distribuidor para que le informen sobre el método correcto de eliminación.

LO SIGUIENTE SÓLO INTERESA A CANADÁ.

Este aparato digital de la clase B cumple con ICES-003 canadiense.

Información para su seguridad

Mantenga la unidad lo más lejos que sea posible de equipos electromagnéticos (como hornos de microondas, televisores, vídeo juegos, transmisores radio, líneas de alto voltaje, etc.).

- No utilice la cámara cerca de teléfonos móviles, ya que lo de hacerlo puede producir ruido que afectará negativamente a las imágenes y el sonido.
- Si la cámara queda afectada negativamente por un equipo electromagnético y deja de funcionar correctamente, apague la cámara y quite la batería y/o el adaptador de CA conectado. Luego vuelva a insertar la batería y/o vuelva a conectar el adaptador de CA y encienda la cámara.

El objetivo puede usarse con una cámara digital compatible con el estándar de montaje de objetivos del "Micro Four Thirds™ System".

- No se puede montar en una cámara con estándar de soporte Four Thirds™.
- Las figuras de la cámara digital en estas instrucciones de funcionamiento muestran la DMC-G3 en concepto de ejemplo.
- El aspecto y las especificaciones de los productos descritos en este manual pueden diferir de los productos reales que usted ha comprado debido a aumentos sucesivos.
- El logotipo Micro Four Thirds™ y Micro Four Thirds son marcas comerciales o marcas comerciales registradas de Olympus Corporation, en Japón, Estados Unidos, la Unión Europea y otros países.
- El logotipo Four Thirds™ y Four Thirds son marcas comerciales o marcas comerciales registradas de Olympus Corporation, en Japón, Estados Unidos, la Unión Europea y otros países.
- G MICRO SYSTEM es un sistema de cámara digital con objetivo intercambiable de LUMIX basado en el estándar Micro Four Thirds System.

- LEICA es una marca registrada de Leica Microsystems IR GmbH. SUMMILUX es una marca registrada de Leica Camera AG. Los objetivos LEICA DG se fabrican usando instrumentos de medida y sistemas de garantía de calidad certificados por Leica Camera AG en base a los estándares de calidad de la compañía.
- Los nombres de los sistemas y productos que se mencionan en estas instrucciones generalmente son marcas comerciales registradas o marcas comerciales de los fabricantes que desarrollaron el sistema o producto en cuestión.

LO SIGUIENTE SÓLO SE APLICA EN LOS EE. UU.

Notas FCC:

Se ensayó este equipo y se comprobó que está de conformidad con los límites de un dispositivo digital de la clase B, de acuerdo con la Parte 15 de las Reglas FCC.

Estos límites se han ideado para proporcionar una razonable protección contra las interferencias dañinas en una instalación residencial. Este equipo genera, utiliza y puede radiar energía de frecuencia radio y, por si no se instala y se utiliza de acuerdo con las instrucciones, puede ocasionar interferencia dañina a las comunicaciones radio. Aunque no hay garantía de que no pueda tener lugar interferencia en especiales instalaciones. Si este equipo causa interferencia a la recepción de radio o televisión que pueden determinarse apagando y encendiendo el equipo, se anima al usuario intentar corregir la interferencia tomando una de las medidas a continuación:

- Vuelva a orientar o a colocar la antena receptora.
- Aumente la separación entre el equipo y el receptor.
- Conecte el equipo a una toma de un circuito diferente del que está conectado el receptor.
- Llame al concesionario o un técnico experto de radio y televisión para ayuda.

Todo cambio o modificación a este equipo sin autorizar invalidará el título del usuario para hacer funcionar este dispositivo.

Este dispositivo cumple con la Parte 15 de las Reglas FCC. El funcionamiento está sujeto a las dos condiciones a continuación: (1) Este dispositivo podría no causar interferencia dañina y (2) este dispositivo tiene que aceptar toda la interferencia recibida, incluyendo la que puede causar un funcionamiento no deseado.

Parte responsable:

Panasonic Corporation of North America
Two Riverfront Plaza, Newark, NJ 07102-5490

Contacto para atención: <http://www.panasonic.com/contactinfo>

■ Atención del objetivo

- La arena y el polvo pueden dañar el objetivo. Cuando usa el objetivo en una playa, tenga cuidado de que ni arena ni polvo entren en el interior del objetivo o los terminales, etc.
- Este objetivo no es impermeable. Si caen gotas de agua en el objetivo, límpielo con un paño seco.
- No ejerce demasiada presión en el objetivo.
- Cuando hay suciedad (agua, aceite, huellas dactilares, etc.) en la superficie del objetivo, la imagen puede salir afectada. Limpie ligeramente con un paño blando y seco antes y después de tomar las imágenes.
- No meta el soporte del objetivo mirando hacia abajo. No deje que se ensucien los punto de contacto ①.

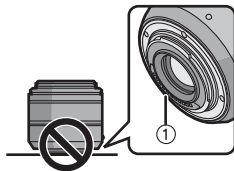

■ Acerca de la condensación (Empañamiento del objetivo)

- La condensación ocurre cuando se encuentra una diferencia en la temperatura y humedad como se describe abajo. La condensación puede hacer ensuciar el objetivo y producir hongos y un funcionamiento defectuoso, por lo tanto ponga cuidado en las situaciones a continuación:
 - Cuando lleva la cámara en casa desde el aire libre durante un tiempo frío
 - Cuando lleva la cámara dentro de un coche con aire acondicionado
 - Cuando sopla en el objetivo aire frío desde un acondicionador de aire
 - En lugares húmedos
- Para impedir la condensación, meta la cámara en una bolsa de plástico para que se aclimate a la temperatura ambiente. Si ocurre condensación, apague la alimentación y la deje así durante dos horas. Una vez de que la cámara se haya aclimatado a la temperatura ambiente en empañamiento desaparece naturalmente.





Accesorios suministrados

[Controles a realizar cuando va a desembalar la unidad]

Al quitar la unidad de su embalaje, compruebe que se encuentren la unidad principal y los accesorios suministrados. Además compruebe el aspecto externo y las funciones para verificar que no hayan padecido daños durante la distribución y el transporte.

Por si encuentra un cualquier problema, antes de usar el producto llame a su comerciante.

Los números de producto se aplican desde julio de 2011. Estos pueden estar sujetos a modificaciones.

1 	2 	3 	4 
VFC4456	VYC1063	VYF3284	VFC4605

- 1** Bolsa de almacenamiento del objetivo
- 2** Visera del objetivo
- 3** Tapa del objetivo
- 4** Tapa trasera del objetivo
(La tapa trasera del objetivo y la tapa del objetivo intercambiable al momento de la compra.)

Unir y quitar el objetivo

- Se refiera también a las instrucciones de funcionamiento de la cámara para unir y separar el objetivo.

■ Unión del objetivo

- Compruebe que la cámara esté apagada.

1 Gire la tapa trasera del objetivo para separarla.

- (A): Tapa trasera del objetivo

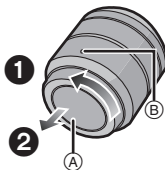

2 Alinee las marcas para ajustar el objetivo (B) (marcas rojas) ubicadas en el cuerpo de la cámara y el mismo objetivo, luego gire éste en la dirección de la flecha hasta que dispare.



- No presione el botón de liberación de la lente (C) cuando coloca una lente.
- Como el soporte del objetivo podría salir rayado, no trate de unir el objetivo a la cámara manteniéndolo de ángulo.
- Compruebe que el objetivo esté unido correctamente.

■ Separación del objetivo

- Compruebe que la cámara esté apagada.

Mientras presiona el botón de liberación de la lente **(D)**, gire la lente hacia la flecha hasta que se detenga y luego retírela.

- Una la tapa trasera de manera que el punto de contacto del objetivo no salga rayado.
- Una la tapa del cuerpo a la cámara para que ni suciedad ni polvo entren dentro de la unidad principal.



■ Unir y separar la tapa del objetivo

Aprete la tapa de la lente como se muestra en la figura para colocarla o sacarla.

- Ponga cuidado en no perder la tapa del objetivo.

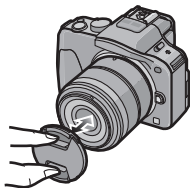

■ Unión de la visera del objetivo (Accesorio suministrado)

Inserte la visera del objetivo con las partes cortas arriba y abajo, luego gírela en la dirección de la flecha hasta que dispare.

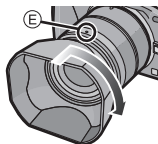

(E): Ajustando hacia la marca

- Cuando toma las imágenes con el flash y tiene unida la visera del objetivo, la porción inferior de la pantalla podría ponerse oscura (efecto de viñeteado) y el control del flash podría inhabilitarse debido a que éste podría ser oscurecido por la misma visera. Le recomendamos que quite dicha visera.
- Cuando usa la lámpara de ayuda AF en la oscuridad, quite la visera del objetivo.

■ Unión de los filtros

- Puede tener lugar viñeteado si usa 2 o más protectores MC (opcionales: DMW-LMC46), filtros PL (opcionales: DMW-LPL46) o filtros ND (opcionales: DMW-LND46), o bien si usa protectores y/o filtros espesos.
- Tal vez sea imposible de retirar el filtro si está demasiado apretado, por lo que no debe apretarlo demasiado fuerte.
- Se puede colocar la tapa del objetivo con el filtro ya colocado.
- No consigue acoplar un objetivo de conversión o adaptador a este objetivo. Puede usarse un filtro, pero acoplar cualquier otro elemento puede dañar el objetivo.

Nombres y funciones de los componentes

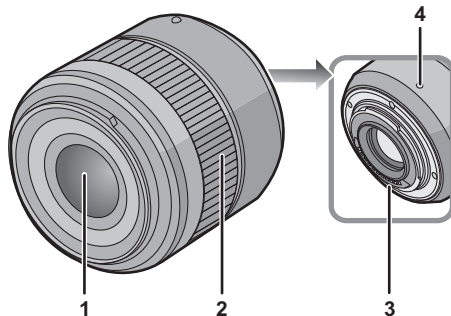

- 1 Superficie del objetivo
- 2 Anillo del enfoque
Ruotare per mettere a fuoco quando si scattano fotografie utilizzando la messa a fuoco manuale.
- 3 Punto de contacto
- 4 Marca para ajustar el objetivo



Nota

- El cambio en la imagen con la operación de enfoque puede ser más visible según la condición de grabación cuando la función AF opera durante la grabación de imágenes en movimiento. Se recomienda fijar el enfoque al ajustar la cámara en el enfoque manual (MF), etc. cuando el cambio de imagen lo molesta.

Precauciones para el uso

Tenga cuidado de no hacer caer el objetivo ni le choque contra. Asimismo tenga cuidado de no presionarlo demasiado.

- Tenga cuidado de no hacer caer la bolsa en la que cabe el objetivo. Éste podría dañarse, la cámara podría dejar de funcionar normalmente y las imágenes ya podrían no grabarse.

Cuando usa pesticidas y otras sustancias volátiles alrededor de la cámara tenga cuidado de que no entre en el objetivo.

- Si dichas sustancias caen en el objetivo, éstas pueden dañarlo o hacer desconchar su barniz.

No transporte la unidad si ésta está todavía unida al cuerpo de la cámara.

- De ninguna manera la unidad debe ser usada o almacenada en uno de los siguientes lugares ya que lo de hacerlo podría perjudicarla o producir un funcionamiento defectuoso.
 - Bajo la luz directa del sol o bien a lo largo de la costa durante el verano

- En lugares donde haya altas temperaturas o altos niveles de humedad o bien donde sean repentinos los cambios de temperatura y humedad
- En lugares donde haya altas concentraciones de arena, polvo o suciedad
- Donde haya llamas
- Cerca de calefactores, acondicionadores de aire o humidificadores
- Donde el agua puede hacer mojar la unidad
- Donde haya vibraciones
- Dentro de un vehículo
- Se refiera también a las instrucciones de funcionamiento de la cámara digital.
- Cuando no ha de ser usada la unidad por un período prolongado, le recomendamos guardar con un desecante (silicagel). El hecho de no hacerlo podría ocasionar una avería causada por el moho etc. Se recomienda que compruebe el funcionamiento de la unidad antes de usarla.
- No deje el objetivo en contacto con productos de plástico durante largos períodos de tiempo.
- No toque los contactos eléctricos de la unidad. Lo de hacerlo puede causar avería en la unidad.
- No desmonte ni modifique la unidad.

No utilice gasolina, diluyente, alcohol u otros agentes de limpieza parecidos para limpiar la unidad.

- El hecho de usar disolventes puede dañar el objetivo y hacer desconchar su barniz.
- Quite cualquier indicio de polvo o huellas dactilares con un paño blando y seco.
- Use un paño suave y seco para eliminar suciedad y polvo de la anilla de enfoque.
- No use detergentes para cocina o un paño tratado químicamente.

Búsqueda de averías

Se oye un sonido cuando se enciende o se apaga la cámara.

Se escucha un sonido desde la lente al tomar la imagen de un sujeto brillante como en exteriores.

- Éste es el sonido del objetivo o el movimiento de abertura y no es un funcionamiento defectuoso.

Especificaciones

ÓPTICA INTERCAMBIABLE PARA CÁMARA DIGITAL "LEICA DG SUMMILUX 25 mm/F1.4 ASPH."

Longitud focal	f=25 mm (Igual a una cámara de película de 35 mm: 50 mm)
Tipo de abertura	7 aspas de diafragma/Diafragma de apertura circular
Gama de abertura	F1.4
Valor de abertura mínimo	F16
Estructura del objetivo	9 elementos en 7 grupos (2 objetivos esféricos)
En la distancia del enfoque	0,3 m (0,99 pies) a ∞ (desde la línea de referencia de la distancia del enfoque)
Máxima ampliación de la imagen	0,11× (Igual a una cámara de película de 35 mm: 0,22×)
Estabilizador óptico de la imagen	No disponible
Soporte	"Micro Four Thirds Mount"
Ángulo visual	47°
Diámetro del filtro	46 mm (1,81 pulgadas)
Diámetro máx.	Aprox. 63 mm (2,48 pulgadas)
Longitud total	Aprox. 54,5 mm (2,15 pulgadas) (desde la punta del objetivo hasta la base lateral de la montura del objetivo)
Peso	Aprox. 200 g (0,44 lb)

Panasonic Corporation of North America
Two Riverfront Plaza, Newark, NJ 07102-5490
<http://shop.panasonic.com>

Panasonic Canada Inc.
5770 Ambler Drive, Mississauga, Ontario, L4W 2T3
www.panasonic.com

© Panasonic Corporation 2011

Printed in Japan