

Operating Instructions LCD Television Manual de instrucciones Televisor LCD

Model No. **TC-23LX60**
 Número de modelo **TC-26LX60C**
TC-26LX60L
TC-32LX60C
TC-32LX60L



HDMI™
HIGH-DEFINITION MULTIMEDIA INTERFACE

For assistance, please call : 1-800-211-PANA (7262)
 or contact us at www.panasonic.com/contactinfo (U.S.A.)

For assistance, please call : 787-750-4300
 or visit us at www.panasonic.com (Puerto Rico)

For assistance, please call : 1-800-561-5505
 or visit us at www.panasonic.ca (Canada)

Para solicitar ayuda, llame al: 1-800-211-PANA (7262)
 o visítenos en www.panasonic.com/contactinfo (EE.UU.)

Para solicitar ayuda, llame al: 787-750-4300
 o visítenos en www.panasonic.com (Puerto Rico)

Customer's Record

The model number and serial number of this product can be found on its back cover. You should note this serial number in the space provided below and retain this book, plus your purchase receipt, as a permanent record of your purchase to aid in identification in the event of theft or loss, and for Warranty Service purposes.

Model Number _____ Serial Number _____

Anotación del cliente

El modelo y el número de serie de este producto se encuentran en su panel posterior. Deberá anotarlos en el espacio provisto a continuación y guardar este manual, más el recibo de su compra, como prueba permanente de su adquisición, para que le sirva de ayuda al identificarlo en el caso de que le sea sustraído o lo pierda, y también para disponer de los servicios que le ofrece la garantía.

Modelo _____ Número de serie _____

Panasonic Consumer Electronics Company, Division of Panasonic Corporation of North America
 One Panasonic Way, Secaucus
 New Jersey 07094 U.S.A.

Panasonic Puerto Rico Inc. ("PSC")
 Ave. 65 de Infantería, Km 9.5
 San Gabriel Industrial Park,
 Carolina, Puerto Rico 00985

Panasonic Canada Inc.
 5770 Ambler Drive
 Mississauga, Ontario
 L4W 2T3 CANADA

English

Español

Please read these instructions before operating your set and retain them for future reference.
 The images shown in this manual are for illustrative purposes only.

Lea estas instrucciones antes de utilizar su televisor y guárdelas para consultarlas en el futuro.
 Las imágenes mostradas en este manual tienen solamente fines ilustrativos.

Turn your own living room into a movie theater!
 Experience an amazing level of multimedia excitement

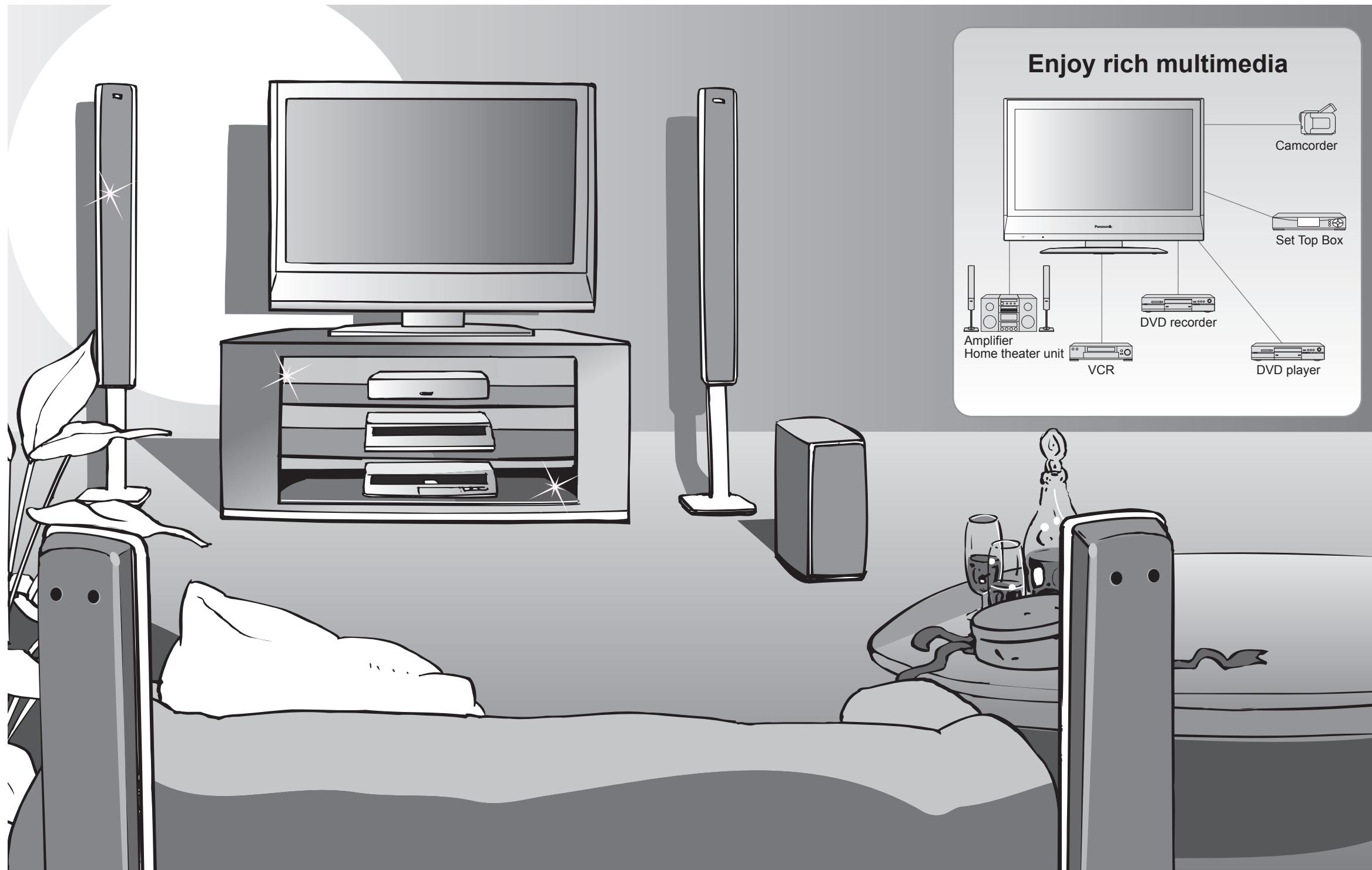

Contents

Please read before using the unit

- Important Safety Instructions 4
- Accessories/Options 6
- **Connection** 8
- Identifying Controls 9

Enjoy your TV !

Basic Features

- Watching TV..... 10
- Watching Videos and DVDs..... 11

Advanced Features

- How to Use Menu Functions
 (picture, sound quality, etc.) 12
- Input Labels/Closed Caption 14
- Editing and Setting Channels 15
- Lock 16
- Operating Peripheral Equipment 18
- Control with HDMI "HDAVI Control™" 19
- Recommended AV Connections 20

FAQs, etc.

- Remote Control Operation/Code List..... 22
- Ratings List for Channel Lock 25
- Technical Information 26
- Maintenance 28
- FAQ 28
- Specifications 30
- Limited Warranty (for U.S.A.) 31
- Customer Services Directory (for U. S. A.) 32
- Limited Warranty (for Canada) 33

Quick Start Guide

Viewing

Advanced

FAQs, etc.



HDMI, the HDMI logo and High-Definition Multimedia Interface are trademarks or registered trademarks of HDMI Licensing LLC.

HDAVI Control™

HDAVI Control™ is a trademark of Matsushita Electric Industrial Co., Ltd.



Important Safety Instructions



CAUTION

RISK OF ELECTRIC SHOCK

DO NOT OPEN



WARNING: To reduce the risk of electric shock, do not remove cover or back. No user-serviceable parts inside. Refer servicing to qualified service personnel.



The lightning flash with arrow head within a triangle is intended to tell the user that parts inside the product are a risk of electric shock to persons.



The exclamation point within a triangle is intended to tell the user that important operating and servicing instructions are in the papers with the appliance.

Note to CATV System Installer

This reminder is provided to direct the CATV system installer's attention to Article 820-40 of the NEC that provides guidelines for proper grounding and, in particular, specifies that the cable ground shall be connected to the grounding system of the building, as close to the point of cable entry as practical.

Secure ventilation

Slots and openings in the cabinet and the back or bottom are provided for ventilation, and to ensure reliable operation of the LCD TV and to protect it from overheating. These openings must not be blocked or covered. There should be at least 10 cm of space from these openings. The openings should never be blocked by placing the LCD TV on a bed, sofa, rug or other similar surface. This LCD TV should not be placed in a built-in installation such as a bookcase unless proper ventilation is provided.

Important Safety Instructions for LCD TV

- 1) Read these instructions.
- 2) Keep these instructions.
- 3) Heed all warnings.
- 4) Follow all instructions.
- 5) Do not use this apparatus near water.
- 6) Clean only with dry cloth.
- 7) Do not block any ventilation openings. Install in accordance with the manufacturer's instructions.
- 8) Do not install near any heat sources such as radiators, heat registers, stoves, or other apparatus (including amplifiers) that produce heat.
- 9) Do not defeat the safety purpose of the polarized or grounding-type plug. A polarized plug has two blades with one wider than the other. A grounding type plug has two blades and a third grounding prong. The wide blade or the third prong are provided for your safety. If the provided plug does not fit into your outlet, consult an electrician for replacement of the obsolete outlet.
- 10) Protect the power cord from being walked on or pinched particularly at plugs, convenience receptacles, and the point where they exit from the apparatus.
- 11) Only use attachments / accessories specified by the manufacturer.
- 12) Use only with the cart, stand, tripod, bracket, or table specified by the manufacturer, or sold with the apparatus. When a cart is used, use caution when moving the cart / apparatus combination to avoid injury from tip-over.
- 13) Unplug this apparatus during lightning storms or when unused for long periods of time.
- 14) Refer all servicing to qualified service personnel. Servicing is required when the apparatus has been damaged in any way, such as power-supply cord or plug is damaged, liquid has been spilled or objects have fallen into the apparatus, the apparatus has been exposed to rain or moisture, does not operate normally, or has been dropped.
- 15) Operate only from the type of power source indicated on the marking label. If you are not sure of the type of power supplied to your home consult your television dealer or local power company.
- 16) Follow all warnings and instructions marked on the LCD TV.
- 17) Never push objects of any kind into this LCD TV through cabinet slots as they may touch dangerous voltage points or short out parts that could result in a fire or electric shock. Never spill liquid of any kind on the LCD TV.
- 18) If an outside antenna is connected to the television equipment, be sure the antenna system is grounded so as to provide some protection against voltage surges and built up static charges. In the U.S. Section 810-21 of the National Electrical Code provides information with respect to proper grounding of the mast and supporting structure, grounding of the lead-in wire to an antenna discharge unit, size of grounding conductors, location of antenna discharge unit, connection to grounding electrodes, and requirements for the grounding electrode.

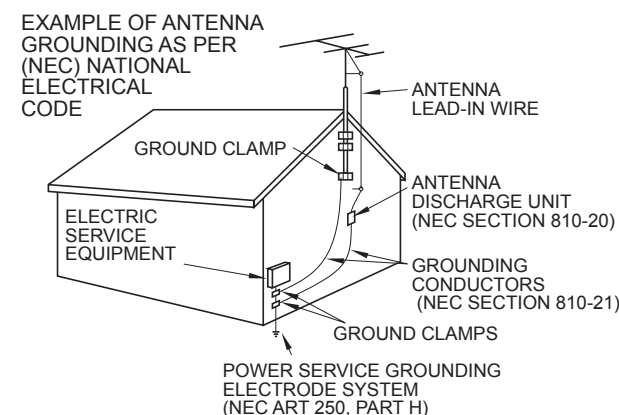

- 19) An outside antenna system should not be located in the vicinity of overhead power lines or other electric light or power circuits, or where it can fall into such power lines or circuits. When installing an outside antenna system extreme care should be taken to keep from touching such power lines or circuits as contact with them might be fatal.
- 20) Unplug this LCD TV from the wall outlet, and refer servicing to qualified service personnel under the following conditions:
 - a. When the power cord or plug is damaged or frayed.
 - b. If liquid has been spilled into the LCD TV.
 - c. If the LCD TV has been exposed to rain or water.
 - d. If the LCD TV does not operate normally by following the operating instructions.

Adjust only those controls that are covered by the operating instructions as improper adjustment of other controls may result in damage and will often require extensive work by a qualified technician to restore the LCD TV to normal operation.
 - e. If the LCD TV has been dropped or the cabinet has been damaged.
 - f. When the LCD TV exhibits a distinct change in performance - this indicates a need for service.
- 21) When replacement parts are required, be sure the service technician uses replacement parts specified by the manufacturer that have the same characteristics as the original parts. Unauthorized substitutions may result in fire, electric shock, or other hazards.
- 22) **WARNING** : TO REDUCE THE RISK OF FIRE OR ELECTRIC SHOCK, DO NOT EXPOSE THIS APPARATUS TO RAIN, MOISTURE, DRIPPING OR SPLASHING. DO NOT PLACE LIQUID CONTAINERS (FLOWER VASES, CUPS, COSMETICS, ETC.) ABOVE THE SET. (INCLUDING ON SHELVES ABOVE, ETC.)
- 23) **WARNING** : SMALL PARTS CAN PRESENT CHOKING HAZARD IF ACCIDENTALLY SWALLOWED. KEEP SMALL PARTS AWAY FROM YOUNG CHILDREN. DISCARD UNNEEDED SMALL PARTS AND OTHER OBJECTS, INCLUDING PACKAGING MATERIALS AND PLASTIC BAGS/SHEETS TO PREVENT THEM FROM BEING PLAYED WITH BY YOUNG CHILDREN, CREATING THE POTENTIAL RISK OF SUFFOCATION.
- 24) **CAUTION** : TO PREVENT ELECTRIC SHOCK DO NOT USE THIS PLUG WITH A RECEPTACLE OR OTHER OUTLET UNLESS THE BLADES CAN BE FULLY INSERTED TO PREVENT BLADE EXPOSURE.
- 25) **CAUTION** : USE WITH OTHER STAND MAY RESULT IN INSTABILITY POSSIBLY CAUSING INJURY.
- 26) **CAUTION** : DANGER OF EXPLOSION IF BATTERY IS INCORRECTLY REPLACED. REPLACE ONLY WITH THE SAME OR EQUIVALENT TYPE.
- 27) **CAUTION** : This LCD TV is for use only with the following optional accessories. Use with any other type of optional accessories may cause instability which could result in the possibility of injury. (All of the following accessories are manufactured by Matsushita Electric Industrial Co., Ltd.)
 - Wall-hanging bracket (Vertical) :
 - TY-WK23LR2W (TC-23LX60)
 - TY-WK32LR2W (TC-26LX60C, TC-26LX60L, TC-32LX60C, TC-32LX60L)

Always be sure to ask a qualified technician to carry out set-up.

NOTE : This equipment is designed to operate in North America and other countries where the broadcasting system and AC house current are exactly the same as in North America.

■ This product utilizes tin-lead solder, and has a fluorescent lamp containing a small amount of mercury. Disposal of these materials may be regulated in your community due to environmental considerations. For disposal or recycling information please contact your local authorities, or the Electronics Industries Alliance: www.eiae.org.

Federal Communication Commission Information

This equipment has been tested and found to comply with the limits for a TV Broadcast Receiver, pursuant to Part 15 of the FCC Rules. These limits are designed to provide reasonable protection against harmful interference in a residential installation. This equipment generates, uses and can radiate radio frequency energy and, if not installed and used in accordance with the instructions, may cause harmful interference to radio communications. However, there is no guarantee that interference will not occur in a particular installation. If this equipment does cause or receive interference, which can be determined by turning equipment off and on, the user is encouraged to try to correct the interference by one or more of the following measures:

Reorient or relocate the TV antenna.
 Increase the separation between TV and other equipment.
 Connect TV into separate outlet from other equipment.
 Consult the dealer or an experienced radio / TV technician for help.

FCC Caution: Any changes or modifications not expressly approved by the party responsible for compliance could void the user's authority to operate this equipment.

Accessories/Options

✓ Check you have all the items shown.

Accessories

- Remote Control Transmitter
- EUR7613Z90R

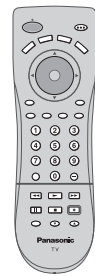

- Batteries for the Remote Control Transmitter (2)
- AA Battery

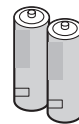

- AC Plug Converter (TC-26LX60L, TC-32LX60L)

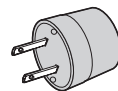

- Product Registration Card (U.S.A.)

- Customer Care Plan Card (U.S.A.)

- Operating Instructions

- Warranty Card (Mexico)

Installing remote's batteries

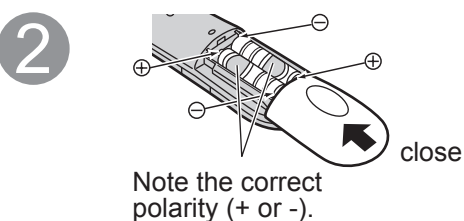
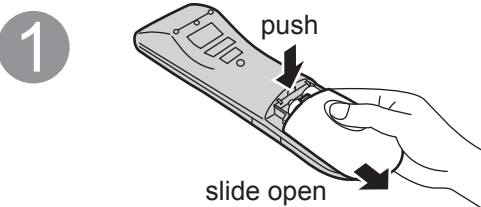

Caution

- Incorrect installation may cause battery leakage and corrosion, resulting in damage to the remote control unit.
- Do not mix old and new batteries.
- Do not mix different battery types (such as alkaline and manganese batteries).
- Do not use rechargeable (Ni-Cd) batteries.
- Do not burn or break batteries.
- Make a note of the remote control codes before changing batteries in case the codes are reset. (p. 23-24)

Optional accessory

Caution

Please contact your nearest Panasonic dealer to purchase the recommended wall-hanging bracket. For additional details, please refer to the wall-hanging bracket installation manual.

Wall-hanging bracket (vertical)

- TY-WK23LR2W (TC-23LX60)

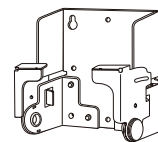

- TY-WK32LR2W (TC-26LX60C, TC-26LX60L, TC-32LX60C, TC-32LX60L)

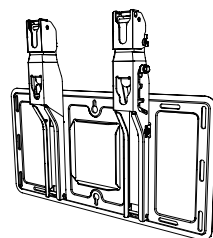

WARNING

- Failure to use a Panasonic bracket or choosing to mount the unit yourself will be done at the risk of the consumer. Any damage resulting from not having a professional installer mount your unit will void your warranty.
- Always be sure to ask a qualified technician to carry out set-up. Incorrect fitting may cause equipment to fall, resulting in injury and product damage.
- Do not mount this LCD Television directly below ceiling lights (such as spotlights, floodlights or halogen lights) which typically give off high heat. Doing so may warp or damage plastic cabinet parts.

How to remove the TV-Stand

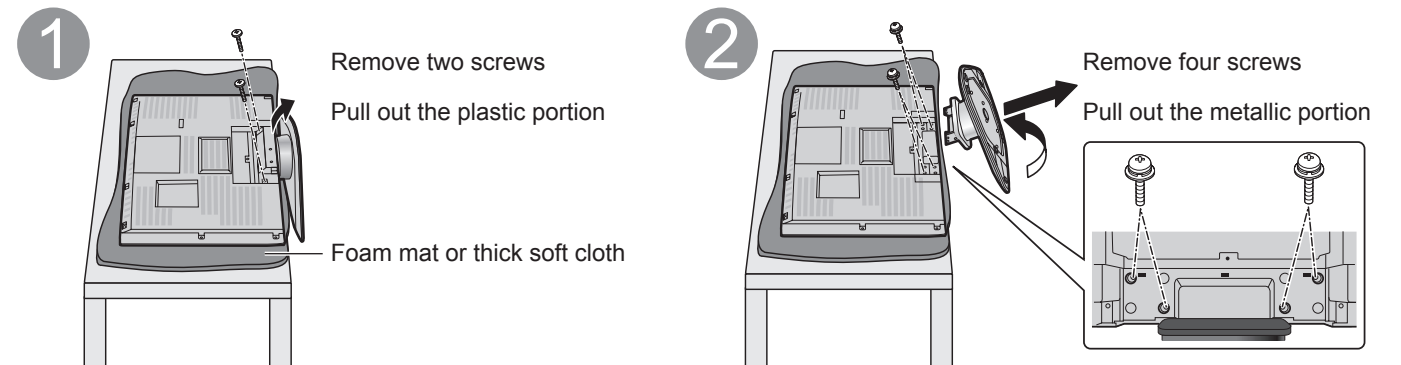

Receiver Location

Locate at a comfortable distance for viewing. Avoid placing where sunlight or other bright light (including reflections) will fall on the screen. Use of some types of fluorescent lighting can reduce remote control transmitter range. Adequate ventilation is essential to prevent internal component failure. Keep away from areas of excessive heat or moisture.

How to use the LCD stand

Adjust the stand to your desired angle.

[TC-23LX60]

The stand angle can be adjusted between 5° forward and 10° back, and rotated 20° to the right / left.

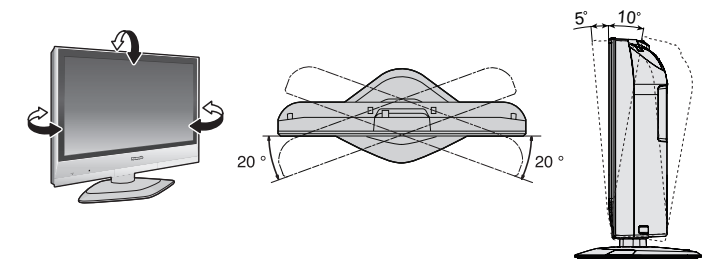

[TC-26LX60C / TC-26LX60L / TC-32LX60C / TC-32LX60L]

The stand angle can be rotated 20° to the right / left.

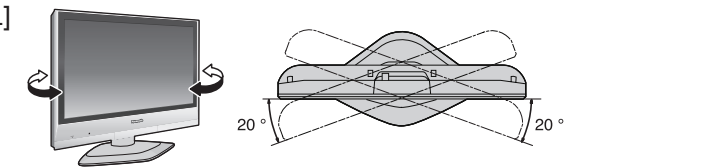

Connection

■ Watching TV

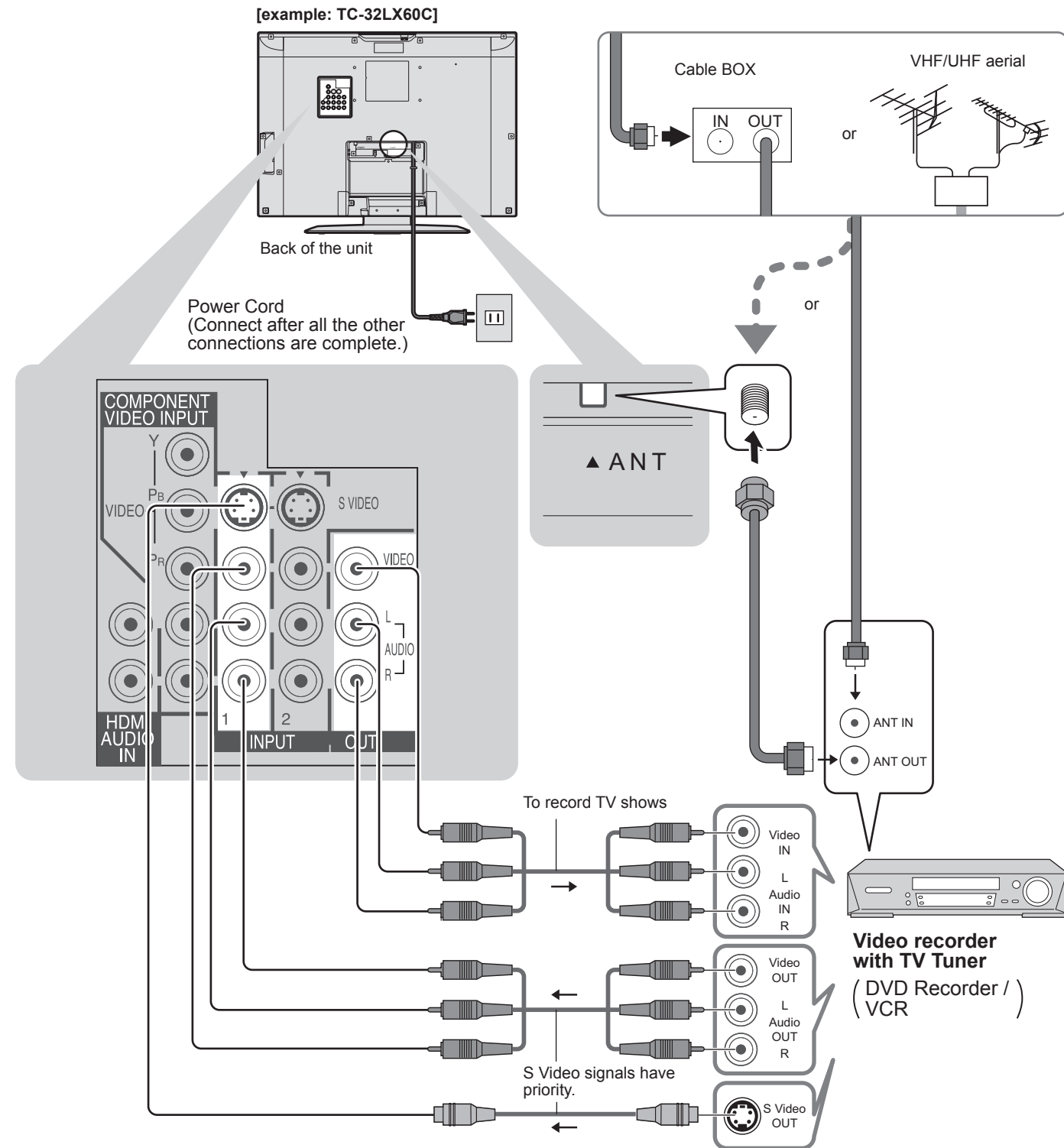

Note

- All cables and external equipments shown in this book are not supplied with the TV.
- For additional assistance, visit us at: www.panasonic.com
www.panasonic.ca
- When connecting video cables, priority is given to the S Video cable when both the S VIDEO input terminal and the VIDEO input terminal are connected.
- Some programs contain a copyright protection to prevent VCR recording.

Identifying Controls

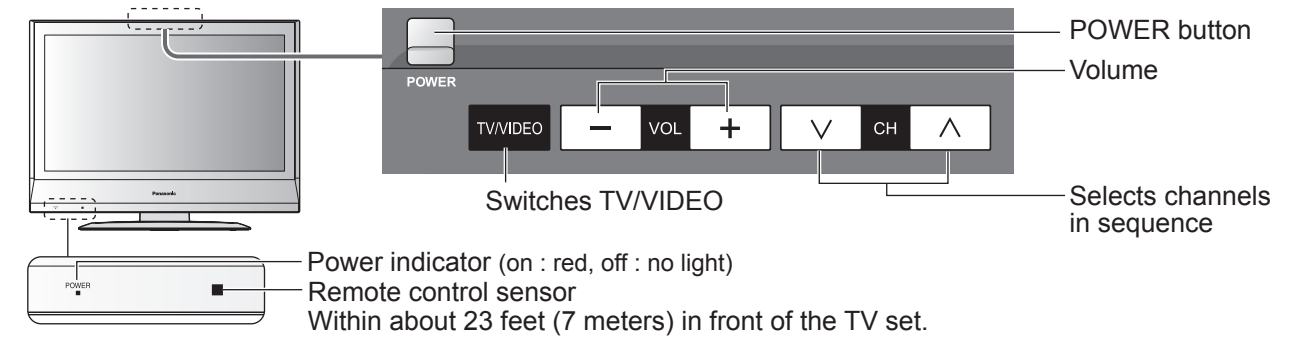

Note

- The TV consumes some power as long as the power cord is inserted into the wall outlet.

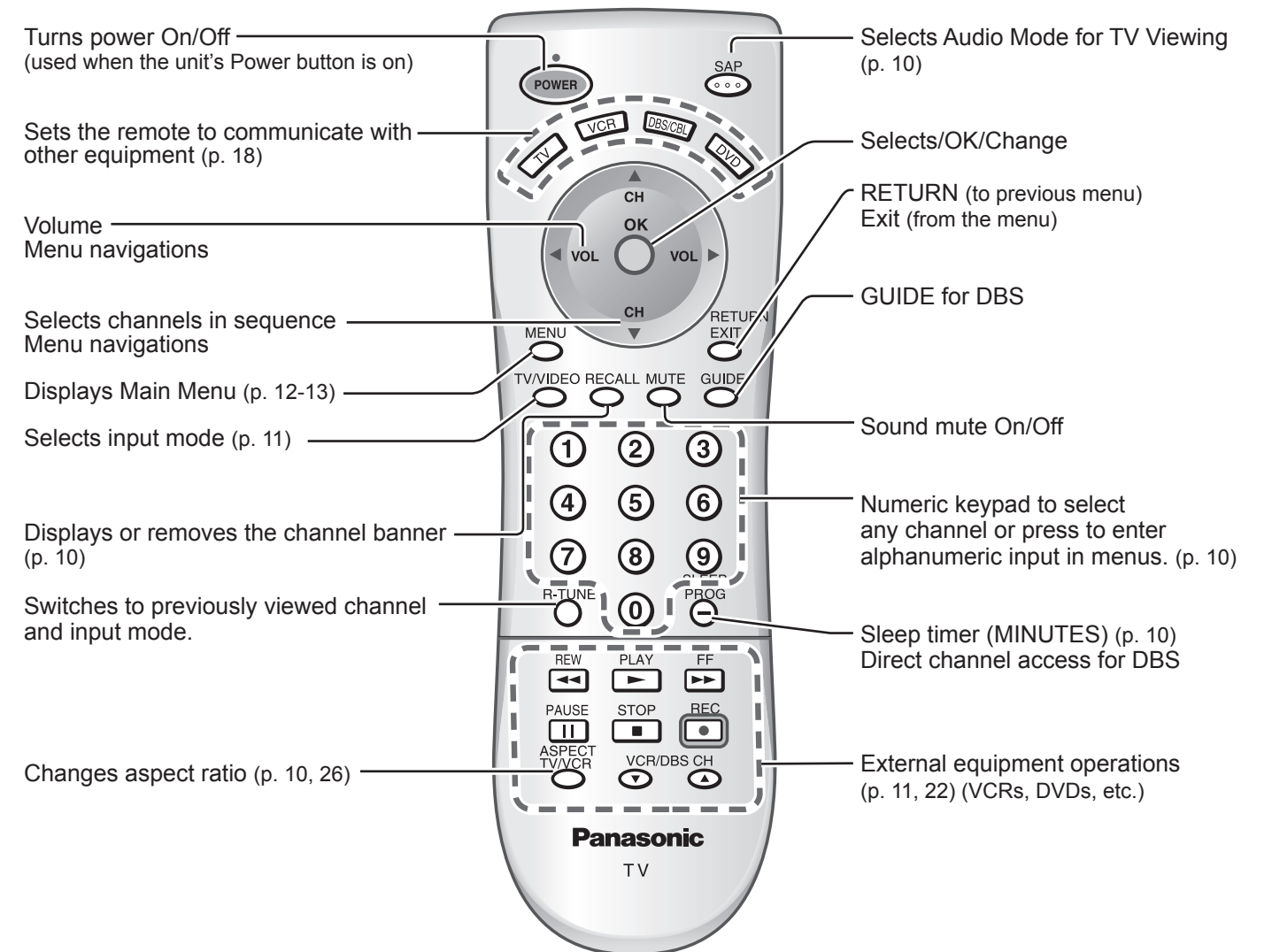

Watching TV

Connect cable Box when watching cable TV. (p. 8)

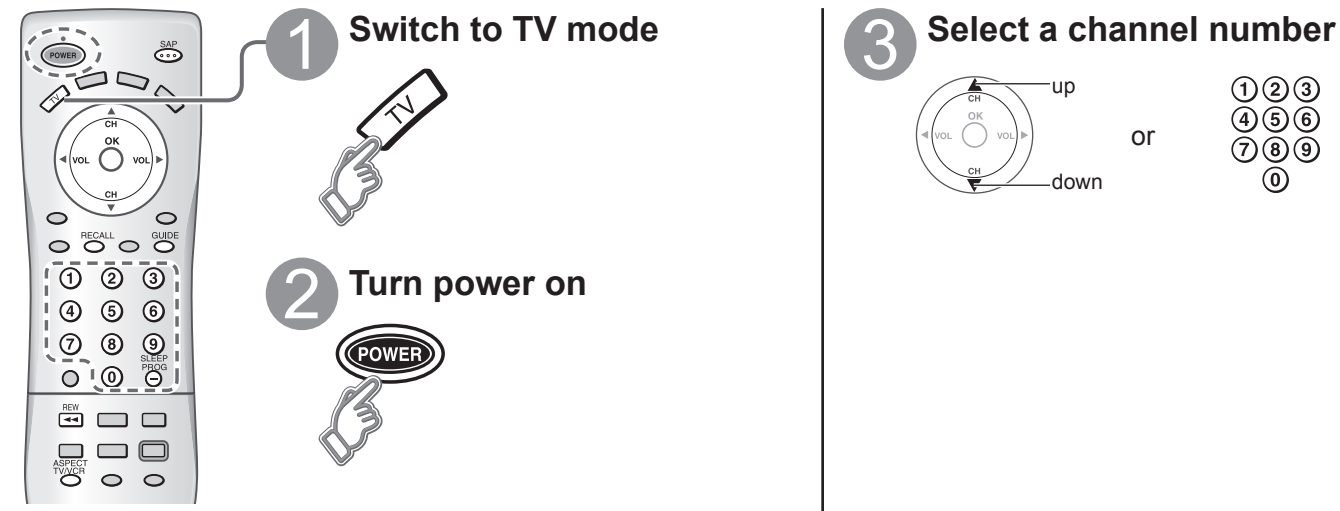

■ Other Useful Functions (Operate after ③)

Sleep Timer	<p>Switches the unit OFF in a preset amount of time from 0 to 90 minutes in 30 minute intervals.</p> <ul style="list-style-type: none"> ● 0/30/60/90 (minutes) 						
Listen with SAP (Secondary Audio Program)	<p>■ Selects Audio Mode for TV Viewing</p> <p>Press SAP to select the desired audio mode.</p> <ul style="list-style-type: none"> • Each press of SAP will change the audio mode. (Stereo/SAP/Mono) • Red display : With signal • White display : No signal • White display (All modes) : Mono <table border="1"> <tr> <td>Stereo</td> <td>Two channel Audio reception.</td> </tr> <tr> <td>SAP</td> <td>Second Audio Programming (typically used for bilingual audio).</td> </tr> <tr> <td>Mono</td> <td>Select when stereo signal is weak.</td> </tr> </table>	Stereo	Two channel Audio reception.	SAP	Second Audio Programming (typically used for bilingual audio).	Mono	Select when stereo signal is weak.
Stereo	Two channel Audio reception.						
SAP	Second Audio Programming (typically used for bilingual audio).						
Mono	Select when stereo signal is weak.						
Information Recall	<p> Displays or removes the channel banner.</p> <p>Ch/input mode</p> <p>Picture mode</p>						
Change aspect ratio	<p> Change the aspect (p. 26)</p> <ul style="list-style-type: none"> ● Press button to cycle through the aspect modes. • 480i, 480p:FULL/JUST/4:3/ZOOM • 1080i, 720p:FULL/H-FILL/JUST/4:3 						

Note

- Reselect "Cable" or "Antenna" in "ANT in" of "Auto program" to switch the signal reception between cable TV and antenna. (p. 15)
- The channel number and volume level remain the same even after the TV is turned off.

Watching Videos and DVDs

Some Panasonic equipment connected to the TV unit can be operated with the remote control. Programming the remote control is necessary to operate other manufacturers' products. (p. 18, 23-24)

1 With VCR or DVD turned On Switch to external input
Press to display the Input select menu. TV/VIDEO

2 Select the input mode

Input select

[1] TV

[2] Component

[3] HDMI

[4] Video1

[5] Video2

[6] Video3

① ② ③

④ ⑤ ⑥

⑦ ⑧ ⑨

⑩

or

① select

② enter

Press the corresponding NUMBER key on the Remote Control to select the input of your choice.

Press to select the input of your choice, then press "OK".

- If during selection, no action is taken for several seconds, the Input selection menu is exited.

[example]

- Video 3 is not available for TC-23LX60.
- The terminal and label of the connected equipment is indicated. To label each of the connected equipment (p. 14)

[example]

■ Press to exit or return to previous screen

RETURN EXIT

Note

- For details, see the manual of the other equipment or ask your local dealer.

3 Operate the VCR or DVD with the remote control

	VCR	DVD
REW FF	Rewind/Fast Forward	Reverse/Forward
PLAY	Play	Play
PAUSE	Pause	Pause
STOP	Stop	Stop
REC	VCR Record	—
ASPECT TV/VCR	TV/VCR	Open/Close
VCR/DBS CH	Channel Down/UP	Slow Reverse/Forward

(For other operations, see p. 22)

How to Use Menu Functions

Various menus allow you to select settings for the picture, sound, and other functions so that you can enjoy watching TV with your preferences set.

1 Display menu
 MENU ● Displays the functions that can be set (varies according to the input signal)

2 Select the menu
 Menu
 □ Picture
 ▶ Audio
 🔒 Lock
 ⚙ Setup

3 Select the item
 Picture 1/2
 Normal Set
 Pic. mode Standard
 Back light +20
 Picture +20
 Brightness 0
 Color 0
 Tint 0
 Sharpness 0

4 Adjust or select
 Picture 1/2
 Normal Set
 Pic. mode Standard
 Back light +20
 Picture +20
 Brightness 0
 Color 0
 Tint 0
 Sharpness 0

■ Press to exit or return to previous screen
 RETURN
 EXIT

Menu list

Menu	Item		
Picture	Normal		
	Pic. mode		
	Back light		
	Picture, Brightness, Color, Tint, Sharpness		
	Color temp		
	AI picture		
	Zoom adjust		
	Other adjust	Video NR	
		3D Y/C filter	
		Color matrix	
Black level			
Audio	Normal		
	Bass		
	Treble		
	Balance		
	Other adjust	AI sound	
		Surround	
		HDMI in	
		Audio leveler	
Lock	SAP		
	Language		
Setup	Program channel		
	Input labels		
	CC		
	Other adjust	Auto power on	
		Prog-out stop	
		Ctrl with HDMI	
		Power save	

Adjustments/Configurations (alternatives)		
Resets all picture adjustments to factory default settings except for "Other adjust"	Normal	Set
Basic picture mode (Vivid/Standard/Cinema) (p. 27)	Pic. mode	Standard
Adjusts luminance of the back light.	Back light	+20
Adjusts color, brightness, etc. for each picture mode to suit your taste	Picture	+20
	Brightness	0
	Color	0
	Tint	0
	Sharpness	0
Selects level of warm colors (red) and cool colors (blue) (Warm/Cool/Normal)	Color temp	Cool
Controls dark areas without affecting the black level or brightness in the overall picture (On/Off)	AI picture	On
Adjusts vertical alignment and size when aspect setting is "ZOOM" (p. 26)	Zoom adjust	
Reduces noise, commonly called snow. Leave off when receiving a strong signal. (On/Off)	Video NR	Off
Minimizes noise and cross-color in the picture. (On/Off) ● Not valid on component and HDMI.	3D Y/C filter	Off
Selects image resolution of component-connected devices (SD/HD) ● SD: normal vision HD: high-definition vision ● Only 480 p signal accepted; regular TV (NTSC) is not available.	Color matrix	SD
Selects Dark or Light depending on the picture conditions, when selecting the video or component input. The dark scene becomes easy to see. (Dark/Light) ● Fixed to Dark when selecting TV mode. ● Fixed to Light when selecting HDMI mode.	Black level	Light
Reset Bass, Treble and Balance adjustments to factory default settings.	Normal	Set
Increase or decrease the bass response.	Bass	+4
Increase or decrease the treble response.	Treble	0
Emphasize the left / right speaker volume.	Balance	0
Equalize overall volume levels across all channels and VIDEO inputs. (On/Off)	AI sound	On
Enhances audio response when listening to stereo. (On/Off)	Surround	Off
Selects according to the signal when HDMI is connected (Auto/Digital/Analog) ● Auto: Automatically selects Analog / Digital signal	HDMI in	Auto
Minimizes volume disparity after switching to external inputs	Audio leveler	0
Selects Audio Mode for TV viewing (Stereo/ SAP/Mono) ● To change the mode using SAP button. (p. 10)	SAP	Stereo
Locks the programs (p. 16-17)	Language	
Selects the screen menu language	Program channel	
Sets receiving channels. (p. 15)	Input labels	
Displays labels of external equipments (p. 14)	CC	
Displays subtitles (Closed Caption) (p. 14)	Auto power on	Off
Sets how to power on the TV. (Set/Off) Set : Connect power cord plug to Cable box etc. and control TV's On/Off on the connected equipment. (The Sleep Timer will not function if Auto power on is set.) Off : Supply Power from wall outlet and control TV's On/Off on TV side.	Prog-out stop	Off
To prevent howling and image oscillation, stops output of the pictures and audio specified in this menu. (p. 21) (Off/Comp./HDMI/Video 1/Video 2/Video 3) ● Video 3 is not available for TC-23LX60. ● Comp./HDMI cannot output video signals regardless of "Prog-out stop" setting.	Ctrl with HDMI	On
Controls equipments connected to HDMI terminals. (p. 19, 20) (On/Off) (for TC-23LX60, TC-26LX60C and TC-32LX60C only)	Power save	Standard
Reduces screen brightness to lower power consumption. Eye-friendly for viewing in a dark room (Standard/Saving)		

● In VIDEO mode, the Audio menu and Setup menu give a smaller number of options.

Input Labels/Closed Caption

- 1 Display menu**
MENU
- 2 Select "Setup"**
Menu
Picture
Audio
Lock
Setup
- 3 Select "Input labels" or "CC"**
Setup
Language
Program channel
Input labels
CC
Other adjust
- 4 Set**
■ Press to exit
RETURN
EXIT

The labels of equipment connected to external input terminals can be indicated for easy recognition on the screen. (In selecting input mode of p. 11 ②)

Select the terminal and the label of the external equipment

● Video 3 is not available for TC-23LX60.

- Terminal: Comp./HDMI/Video1-3
- Label: SKIP*/VCR/DVD/CABLE/DBS/PVR/GAME/AUX/[BLANK]

* If "SKIP" is selected for a non-connected terminal, its input is skipped when switched with TV/VIDEO button.

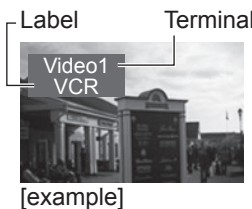

The television includes a built-in decoder that is capable of providing a visual display of the audio portion. The program viewed must provide Closed Captioning (CC) for the television to display it. (p. 26)

■ Select the desired mode

Off: When not using, select "Off".

CC1-4: Information related to pictures (Appears at bottom of screen)

T1-4: Textual information (Appears over entire screen)

Input labels

Display labels of external equipment

CC

Display Closed Caption

Editing and Setting Channels

The current channel settings can be changed according to your needs and reception conditions.

- 1 Display menu**
MENU
- 2 Select "Setup"**
Menu
Picture
Audio
Lock
Setup
- 3 Select "Program channel"**
Setup
Language
Program channel
Input labels
CC
Other adjust
- 4 Select the function**
Program channel
Auto program
Manual program
- 5 Set**

■ Press to exit
RETURN
EXIT

Automatically searches and adds active channels to memory.

- 1 Select "ANT in"**
→ (Select Cable or Antenna)
- 2 Select "Start scan"**

Settings are made automatically

Note

- All previously memorized channels are erased.
- When OK or RETURN/EXIT button is pressed during Auto program, the TV will return to normal viewing. (Channels searched up to that point are added.)
- After Auto program finishes, the lowest channel number added will be displayed.
- When there is no receivable channel, channel 69 (forTV) or channel 125 (for cable TV) is displayed.

Use this procedure when changing the setting of receiving channels or changing the channel display.

- 1 Select Channel**
- 2 Add or delete**
add (the channel number turns blue)
delete (the channel number turns yellow)

● Repeat steps ① and ② for other channels.

- If "Channel lock" (p. 16) is activated and "Auto" or "Manual" is selected, "Enter password." will be displayed.

Lock

You can lock out specified channels or shows to prevent children from watching objectionable content.

1 Display menu
MENU

2 Select "Lock"
You will be asked to enter your password each time you display the Lock menu.

3 Input your 4-digit password
A 4-digit code must be entered to view a blocked program or change rating settings.

4 Select "Program lock"

Menu

- Picture
- Audio
- Lock**
- Setup

Enter password.

● If it is the first time to enter the password, enter the number twice in order to register it.

Lock

- Program lock
- Change password

■ **Press to exit**



Caution

- Make a note of your password in case you forget it. (If you have forgotten your password, consult your local dealer.)

Note

- When you select a locked channel, a message will be displayed that allows you to view the channel if you input your password.

■ **To select the rating of the program to be locked**

Block program

■ **To set rating level**
"V-chip" technology enables restricted shows to be locked according to TV ratings.

① **Select the rating category you wish to follow**

Program lock

- MPAA
- U.S.TV
- C.E.L.R.
- C.F.L.R.
- Monitor out

Off

② **Select the rating to be locked**

Example of "MPAA" (U.S movie ratings)

Off	No rating
G	General Audience: All ages admitted
PG	Parental Guidance Suggested
PG-13	Parents Strongly Cautioned: Inappropriate for children under 13
R	Restricted: Under 17 requires accompanying parent or adult guardian
NC-17	No one 17 and under admitted
X	Adults only

● To get other information (p. 25)

● MPAA:U.S movie ratings
● U.S.TV:U.S TV program ratings
● C.E.L.R.:Canadian English ratings
● C.F.L.R.:Canadian French ratings

■ **To disable recording of the locked program**
➔ Select "Monitor out" in "Program lock" menu and set to "Off"

Program lock

- MPAA
- U.S.TV
- C.E.L.R.
- C.F.L.R.
- Monitor out**

Off

On : Turns on the monitor terminal output for programs that have been set to "Blocked."
Off : Turns off the monitor terminal output for programs that have been set to "Blocked."

Caution

- The V-Chip system that is used in this set is capable of blocking "NR" programs (non rated, not applicable and none) as per FCC Rules Section 15.120(e)(2). If the option of blocking "NR" programs is chosen "unexpected and possibly confusing results may occur, and you may not receive emergency bulletins or any of the following types of programming:"
 - Emergency Bulletins (Such as EAS messages, weather warnings and others)
 - Locally originated programming • News • Political • Public Service Announcements • Religious • Sports
 - Weather

Note

- The Off rating is independent of other ratings.
- When placing a block on a specific age based rating level, the Off rating and any other more restrictive ratings will also be blocked.

Operating Peripheral Equipment

You can operate other manufacturers' equipment using this TV's remote control.

- 1** Connect the external equipment to the TV and **Power Off the external equipment**
- 2** Press both buttons simultaneously for more than 3 seconds.
 - Release the buttons when the equipment selection buttons start flashing.
- 3** Select the equipment with the equipment selection button.
 - The selected button remains lit (other buttons are not lit).
- 4** Input the equipment's 4-digit remote control code (p. 23-24)
- 5** Operate the equipment with the remote control (p. 22)
 - The external equipment turns On.

■ If the equipment does not operate with remote control

- When your equipment has a single code
 - ➔ Input the remote control code again
- When your equipment has multiple codes
 - ➔ Change the code with 4 above and test again

Caution

- Registration will fail if the wrong code is input or it takes more than 30 seconds to register.

To find a code not listed in the code list

This procedure searches all codes and is called the "sequence method."

① After step 3 above, change the code and test



Operate the equipment with the remote control (p. 22)

- Repeat until the code is found
- It may take many attempts before the correct code is found

② When the correct code is found

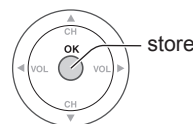

Control with HDMI "HDAVI Control™"

Newer Panasonic audio-video products with HDMI output connections can be controlled using the TV's remote. Limited features such as automatic switching to the TV's HDMI input are available.

- This feature is limited to models incorporating Panasonic's "Control with HDMI". Refer to the individual instruction manuals for compatibility information.
- Non-HDMI-compliant cables cannot be utilized.
- It is recommended that you use Panasonic's HDMI cable.
Recommended part number: RP-CDHG15 (1.5 m), RP-CDHG30 (3.0 m), RP-CDHG50 (5.0 m)

[for TC-23LX60, TC-26LX60C and TC-32LX60C only]

Automatic input switching

When "Ctrl with HDMI" is set to "On", at the start of HDAVI control compatible equipment's playback, the TV's input automatically switches to the input corresponding to the playback equipment.

- If using DIGA operation, the TV's input automatically switches to DIGA and the DIGA menu is displayed. If the TV's power is Off, it is automatically switched On.

Power on link

When "Ctrl with HDMI" is set to "On", the TV is automatically turned on and switched to the appropriate HDMI input whenever HDAVI control compatible equipment is initially turned on and Play mode is selected.

Power off link

When "Ctrl with HDMI" is set to "On" and the TV is turned off, the connected HDAVI control compatible equipment is also automatically turned off.

- DIGA (Panasonic DVD Recorder) will not turn off if it is still in rec mode.

Caution

- "Control with HDMI" function does not work in countries other than the USA and Canada.
- The TV remains on even if the "Control with HDMI" compatible equipment is turned off.

Note

- Before using HDMI control functions, the connected equipment must also be set. For details, see the operation manual for each piece of equipment.
- For equipment connection details, see p. 20.
- Default setting is "On". If no HDMI equipment is connected or standard HDMI equipment (non- "Control with HDMI") is used, set to "Off". (see below)

- 1** Display menu MENU
- 2** Select "Setup"
- 3** Select "Other adjust"
- 4** Select "Ctrl with HDMI"
- 5** Select "On" or "Off"

Press to exit or return to previous screen
RETURN
EXIT

Recommended AV Connections

These diagrams show our recommendations for how to connect the TV unit to your various equipment. For other connections, consult the instructions of each piece of equipment and the specifications (p. 30). For additional assistance, please visit our website at: www.panasonic.com www.panasonic.ca

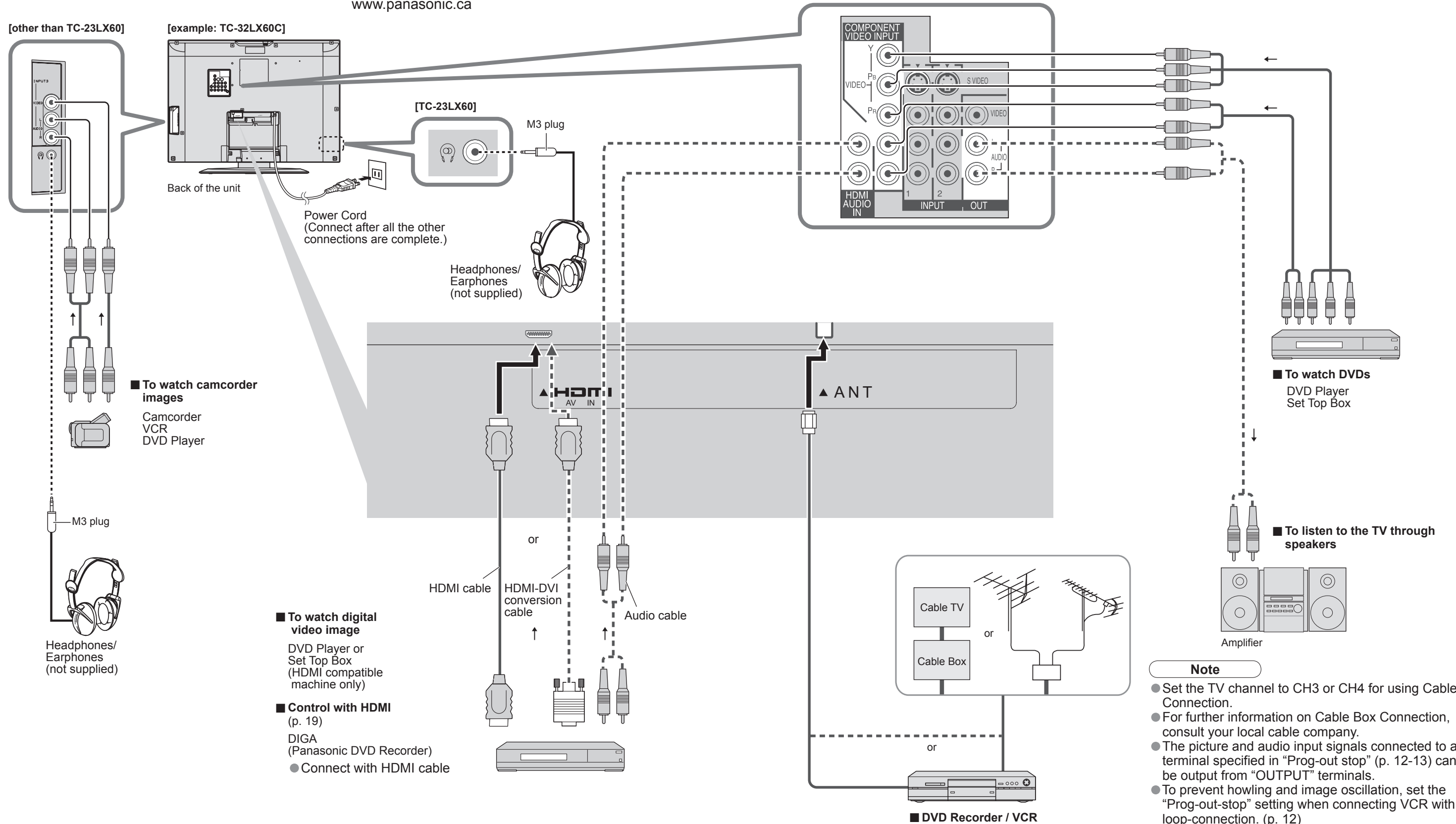

Remote Control Operation/Code List

The following explains how to operate external equipment with the remote control.





















- Register the remote control codes (p. 18) if you want to operate an external equipment of another manufacturer. (p. 23-24)

Note

- Operation may not be possible depending on the available memory size of the remote control.
This remote control is not designed to cover operation of all functions of all models.

Remote Control Operation List

This chart defines which keys are operational after programming (if needed), while in the selected remote control mode, DTV, CABLE, DBS, VCR, DVD.

KEY NAME	VCR MODE	DBS/CBL MODE		DVD MODE
		(DBS)	(CBL)	
	Power	Power	Power	Power
	—	CH Up, Cursor Up	CH Up, Cursor Up	Skip Up
	—	CH Down, Cursor Down	CH Down, Cursor Down	Skip Down
	Vol Down	DBS Cursor Left	CBL Cursor Left	Vol Down
	Vol Up	DBS Cursor Right	CBL Cursor Right	Vol Up
	—	DBS Menu	CBL Menu	—
	—	Exit	Exit	—
	TV Input Switch	TV Input Switch	TV Input Switch	TV Input Switch
	Onscreen Display	Onscreen Display	Recall	Onscreen Display
	TV Mute	TV Mute	TV Mute	TV Mute
	—	Guide	Guide	—
	—	0-9	0-9	—
	Rewind	—	—	Reverse
	Play	—	—	Play
	Fast Forward	—	—	Forward
	Pause	—	—	Pause
	Stop	—	—	Stop
	VCR Record	—	PVR Record *1	—
	TV/VCR	Aspect	Aspect	Open/Close
	Channel Down	Page Down	Page Down	Slow Reverse
	Channel Up	Page Up	Page Up	Slow Forward

*1: Combination type

Remote Control Code List



Codes for VCR

Brand	Code
Admiral	335
Aiwa	332
Akai	314, 315, 316, 329
Audio Dynamic	311, 339
Bell & Howell	305, 313
Broksonic	320, 326
Canon	323, 325
Citizen	306
Craig	305, 306, 329
Curtis Mathes	324, 345
Daewoo	301, 324, 343
DBX	310, 311, 339
Dimensia	345
Emerson	303, 319, 320, 325, 326, 343
Fisher	305, 307, 308, 309, 313
Funai	320, 326, 334
GE	324, 333, 345
Goldstar	306
Gradiente	334
Hitachi	300, 323, 345
Instant Replay	323, 324
Jensen	339
JVC	310, 311, 334, 339
Kenwood	306, 310, 311, 339
LXI	300, 305, 306, 307, 308, 309
Magnavox	323, 324, 331
Marantz	310, 311, 339
Marta	306
Memorex	309, 324
MGA	338, 340, 341, 347, 348
Minolta	300, 345
Mitsubishi	338, 340, 341, 347, 348
Multitech	304, 347
NEC	310, 311, 334, 339
Olympic	323, 324
Optimus	306, 321, 328, 335
Orion	320, 326



Codes for Personal Video Recorders

Brand	Code
Panasonic Replay	100
Philips Tivo	101
Sony Tivo	102

Brand	Code
Panasonic	321, 322, 323, 324
J.C.Penney	300, 305, 310, 311, 324, 339, 345
Pentax	300, 311, 345
Philco	320, 323, 324, 326, 331, 343
Philips	323, 324, 331
Pioneer	323
Proscan	300, 301, 302, 323, 324, 331, 333, 345, 346
Quasar	321, 322, 323, 324
Radio Shack	305, 309, 324, 333, 336, 340
RCA	300, 301, 302, 323, 324, 331, 333, 345, 346
Realistic	305, 309, 324, 336, 340
Samsung	302, 304, 333
Sansui	320, 326, 339, 352
Sanyo	305, 309, 313
Scott	301, 302, 304, 309, 320, 326, 338, 340, 347, 348
Sears	300, 305, 306, 307, 308
Sharp	335, 336
Shintom	317
Signature 2000	335
Singer	317
Sony	328, 329, 330
Sylvania	323, 324, 331
Tashiro	306
Tatung	310, 311, 339
Teac	310, 311, 339
Technics	321, 322, 323, 324
Teknika	324
Toshiba	301, 346
Vector Research	311
Wards	306, 309, 335, 336, 344
Yamaha	305, 310, 311, 339
Zenith	306, 344

Remote Control Operation/Code List



Codes for Cable Box

Brand	Code
ABC	224
Archer	225, 232
Cableview	205, 232
Citizen	205, 222
Curtis	212, 213
Diamond	224, 225, 232
Eagle	229
Eastern	234
GC Brand	205, 232
Gemini	222
General Instrument/ Jerrold	211, 219, 220, 221, 222, 223, 224, 225, 226, 227
Hamlin	212, 218, 240, 241, 242, 245
Hitachi	203, 224
Macom	203, 204, 205
Magnavox	233
Memorex	230
Movietime	205, 232
Oak	202, 237, 239
Panasonic	209, 210, 214
Philips	206, 207, 228, 229, 230
Pioneer	201, 216

Brand	Code
Pulsar	205, 232
Puser	232
RCA	215
Realistic	232
Regal	212, 218, 240, 241, 242, 245
Regency	234
Rembrandt	205, 232, 237
Samsung	205
Scientific Atlanta	211, 212, 213
Slmark	201, 205
Sprucer	205, 210
Stargate	205, 232
Televue	201, 205
Texscan	244
Tocom	235
Toshiba	204
Unika	225, 232
Universal	222, 232
Videoway	206
Viewstar	229, 230
Zenith	200, 217
Zenith /Drae Satellite	200

Codes for DBS



Brand	Code
Dish Network	105, 115, 116
Echo Star (Echostar)	105
Express VU	105, 115
G.E.	106
G.I. (General Instrument)	108
Gradiente	114
Hitachi	103, 111, 112
HNS (Hughes)	103
Magnavox	101, 102

Brand	Code
Panasonic	104
Philips	101, 102
Primestar	108
Proscan	106, 109, 110, 113
RCA	106, 109, 110, 113
Sony	107
Star Choice	103, 108
Toshiba	100
Uniden	101, 102

Codes for DVD



Brand	Code
Denon	100
Ferguson	101
JVC	109
Mitsubishi	105
Nordmende	101
Panasonic	100
Philips	103
Pioneer	102
RCA	101

Brand	Code
Saba	101
Samsung	110
Sharp	108
Sony	104
Technics	100
Thomson	101
Toshiba	103
Yamaha	100
Zenith	107

Ratings List for Channel Lock

“V-chip” technology enables you to lock out channels or shows according to standard ratings set by the entertainment industry. (p. 17)

U.S. MOVIE RATINGS (MPAA)

Off	NO RATING (NOT RATED) AND NA (NOT APPLICABLE) PROGRAMS. Movie has not been rated or rating does not apply.
G	GENERAL AUDIENCES. All ages admitted.
PG	PARENTAL GUIDANCE SUGGESTED. Some material may not be suitable for children.
PG-13	PARENTS STRONGLY CAUTIONED. Some material may be inappropriate for children under 13.
R	RESTRICTED. Under 17 requires accompanying parent or adult guardian.
NC-17	NO ONE 17 AND UNDER ADMITTED.
X	ADULTS ONLY.

U.S. TV PROGRAMS RATINGS (U. S. T. V)

Age-based Group	Age-based Ratings	Possible Content Selections	Description
NR (Not Rated)	TV-NR	● Viewable ● Blocked	Not Rated.
Youth	TV-Y	● Viewable ● Blocked	All children. The themes and elements in this program are specifically designed for a very young audience, including children from ages 2-6.
	TV-Y7	● FV Blocked ● Viewable ● Blocked	Directed to older children. Themes and elements in this program may include mild physical or comedic violence, or may frighten children under the age of 7.
Guidance	TV-G	● Viewable ● Blocked	General audience. It contains little or no violence, no strong language, and little or no sexual dialogue or situations.
	TV-PG	● D,L,S,V (all selected) ● Any combination of D, L, S, V	Parental guidance suggested. The program may contain infrequent coarse language, limited violence, some suggestive sexual dialogue and situations.
	TV-14	● D,L,S,V (all selected) ● Any combination of D, L, S, V	Parents strongly cautioned. This program may contain sophisticated themes, sexual content, strong language and more intense violence.
	TV-MA	● D,L,S,V (all selected) ● Any combination of L, S, V	Mature audiences only. This program may contain mature themes, profane language, graphic violence, and explicit sexual content.

FV: Fantasy/Cartoon Violence. V: Violence S: Sex L: Offensive Language D: Dialogue with sexual content.

CANADIAN ENGLISH RATINGS (C. E. L. R)

E	Exempt - Exempt programming includes: news, sports, documentaries and other information programming, talk shows, music videos, and variety programming.
C	Programming intended for children under age 8. No offensive language, nudity or sexual content.
C8+	Programming generally considered acceptable for children 8 years and over. No profanity, nudity or sexual content.
G	General programming, suitable for all audiences.
PG	Parental Guidance suggested. Some material may not be suitable for children.
14+	Programming contains themes or content which may not be suitable for viewers under the age of 14. Parents are strongly cautioned to exercise discretion in permitting viewing by pre-teens and early teens.
18+	18+ years old. Programming restricted to adults. Contains constant violence or scenes of extreme violence.

CANADIAN FRENCH RATINGS (C. F. L. R)

E	Exempt - Exempt programming.
G	General - Programming intended for audience of all ages. Contains no violence, or the violence content is minimal or is depicted appropriately.
8 ans+	8+ General - Not recommended for young children. Programming intended for a broad audience but contains light or occasional violence. Adult supervision recommended.
13 ans+	Programming may not be suitable for children under the age of 13 - Contains either a few violent scenes or one or more sufficiently violent scenes to affect them. Adult supervision strongly suggested.
16 ans+	Programming may not be suitable for children under the age of 16 - Contains frequent scenes of violence or intense violence.
18 ans+	Programming restricted to adults. Contains constant violence or scenes of extreme violence.

Technical Information

Closed Caption (CC)

- The closed caption is not displayed when you use HDMI connection.
- If analog connected equipment is used for displaying or recording, closed caption (CC) should be set On/Off on the connected equipment.
The CC mode setting of the TV will not affect the analog input.
If CC is set to On on both the connected equipment and the TV, captions from each unit will overlap.

Aspect Ratio

Let you choose the aspect depending on the format of the received signal and your preference. (p. 10) (e.g.: in case of 4:3 image)

● FULL

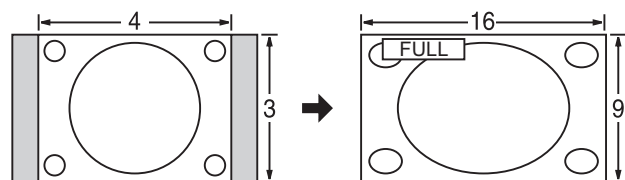

Enlarges the 4:3 image horizontally to the screen's side edges. (Recommended for anamorphic picture)

● JUST

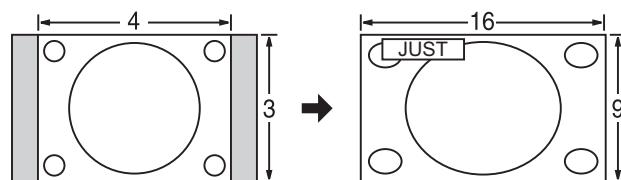

Stretches to justify the 4:3 image to the four corners of the screen. (Recommended for normal TV broadcast)

● H-FILL

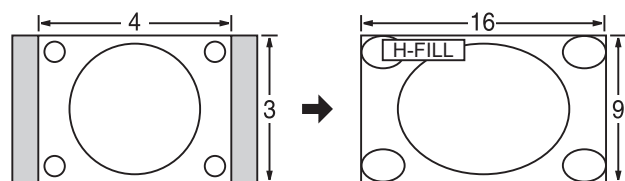

Enlarges the 4:3 image horizontally to the screen's side edges. The side edges of the image are cut off.

● 4:3

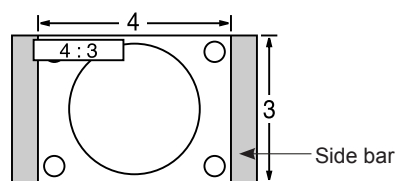

Standard (Note that "after image" of the side bar may occur from displaying it for a long time.)

● ZOOM

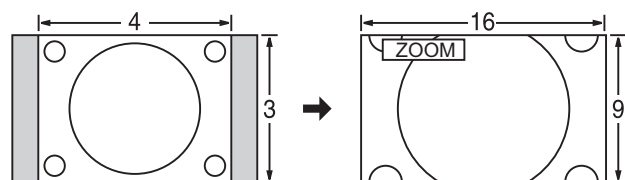

Enlarges the 4:3 image to the entire screen. (Recommended for Letter Box)

Note

- 480i (4:3), 480i (16:9), 480p (4:3), 480p (16:9) : FULL, JUST, 4:3 or ZOOM
- 1080i / 720p : FULL, H-FILL, JUST or 4:3
- When the signal is 720p/1080i, the aspect mode automatically defaults to Full after turning off the TV, after changing input mode, or after changed signal resolution other than 720p/1080i.

● Zoom adjust

Vertical image position and size can be adjusted in "ZOOM."

- ① Select "Zoom adjust" on the "Picture" menu. (p. 12-13)
- ② V-Position: Vertical position adjustment

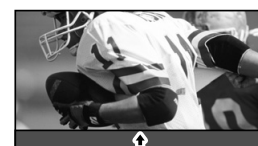
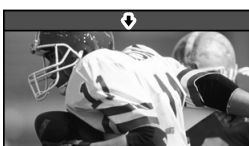

- ③ Size: Vertical size adjustment

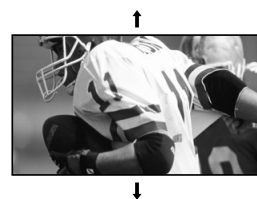

- To reset the aspect ratio → (OK)

Control with HDMI "HDAVI Control™"

HDMI connections to some Panasonic equipment allow you to enjoy easy playback.

- Set up the equipment to enable this function. Read the manual for the equipment.
- Switch the TV unit on again with the equipment on when connection or setup is changed.
- This function may not work normally depending on the equipment condition.
- The equipment can be operated by TV's remote control with this function on even if TV is in Standby mode.
- Image or sound may not be available for the first few seconds when the playback starts.
- Image or sound may not be available for the first few seconds when Input mode is switched.

HDMI connection

HDMI (high-definition multimedia interface) allows you to enjoy high-definition digital images and high-quality sound by connecting the TV unit and the equipment.

HDMI-compatible equipment (*1) with an HDMI or DVI output terminal, such as a set-top box or a DVD player, can be connected to the HDMI connector using an HDMI compliant (fully wired) cable.

- HDMI is the world's first complete digital consumer AV interface complying with a non-compression standard.
- If the external equipment has only a DVI output, connect to the HDMI terminal via a DVI to HDMI adapter cable (*2).
- When the DVI to HDMI adapter cable is used, connect the audio cable to the audio input terminal.
- Audio settings can be made on the "HDMI in" menu screen. (p. 12-13)
Applicable audio signal sampling frequencies (L.PCM): 48 kHz, 44.1 kHz, 32 kHz

(*1): The HDMI logo is displayed on an HDMI-compliant equipment.
(*2): Enquire at your local digital equipment retailer shop.

Caution

- Use with a PC is not assumed.
- All signals are reformatted before being displayed on the screen.
- If the connected equipment has an aspect adjustment function, set the aspect ratio to "16:9".
- This HDMI connector is "type A".
- Equipment having no digital output terminal may be connected to the input terminal of either "COMPONENT", "S-VIDEO", or "VIDEO" to receive analog signals.
- The HDMI input terminal can be used with only the following image signals: 480i, 480p, 720p and 1080i
Match the output setting of the digital equipment.
- For details of the applicable HDMI signals, see below.

Input signals that can be displayed

* Mark: Applicable input signal for Component (Y, P_B, P_R) and HDMI

	horizontal frequency (kHz)	vertical frequency (Hz)	COMPONENT	HDMI
525 (480) / 60i	15.73	59.94	*	*
525 (480) / 60p	31.47	59.94	*	*
750 (720) / 60p	45.00	59.94	*	*
1,125 (1,080) / 60i	33.75	59.94	*	*

Note

- Signals other than those shown above may not be displayed properly.
- The above signals are reformatted for optimal viewing on your display.

Pic. mode

- Vivid (default) : Provides enhanced picture contrast and sharpness for viewing in a well-lit room.
- Standard : Recommended for normal viewing conditions with subdued room lighting.
- Cinema : For watching movies in a darkened room. It provides a soft, film-like picture.

Maintenance

First, unplug the Power cord plug from the wall outlet.

Display panel

The front of the display panel has been specially treated. Wipe the panel surface gently using only a cleaning cloth or a soft, lint-free cloth.

- If the surface is particularly dirty, soak a soft, lint-free cloth in a weak detergent solution and then wring the cloth to remove excess liquid. Use this cloth to wipe the surface of the display panel, then wipe it evenly with a dry cloth, of the same type, until the surface is dry.
- Do not scratch or hit the surface of the panel with fingernails or other hard objects. Furthermore, avoid contact with volatile substances such as insect sprays, solvents and thinners; otherwise, the quality of the surface may be adversely affected.

Cabinet

If the cabinet becomes dirty, wipe it with a soft, dry cloth.

- If the cabinet is particularly dirty, soak the cloth in a weak detergent solution and then wring the cloth dry. Use this cloth to wipe the cabinet, and then wipe it dry with a dry cloth.
- Do not allow any detergent to come into direct contact with the surface of the LCD TV. If water droplets get inside the unit, operating problems may result.
- Avoid contact with volatile substances such as insect sprays, solvents and thinner; otherwise, the quality of the cabinet surface may be adversely affected or the coating may peel off. Furthermore, do not leave it for long periods in contact with articles made from rubber or PVC.

Power cord plug

Wipe the plug with a dry cloth at regular intervals. (Moisture and dust can lead to fire or electrical shock.)

FAQ

Before requesting service or assistance, please follow these simple guidelines to resolve the problem.

If problem still persists, please contact your local Panasonic dealer or Panasonic Servicenter for assistance. For details (p. 32, 33)

For additional assistance, please contact us via the website at:

www.panasonic.com/contactinfo

www.panasonic.ca

White spots or shadow images (noise)

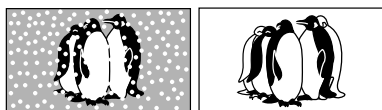

- Check the position, direction, and connection of the aerial.

The LCD panel moves slightly when it is pushed with a finger

Clattered sound might be heard

- There are some looseness around the panel to prevent the damage to the panel. The panel might move slightly when it is pushed with a finger, and clattered sound might be heard. This is not a malfunction.

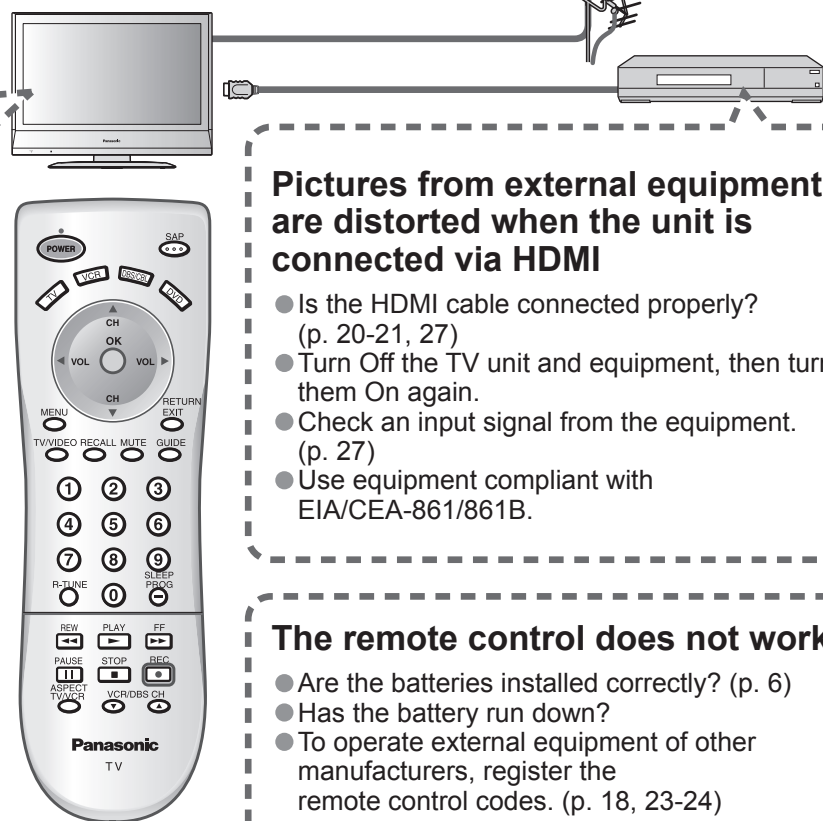

Pictures from external equipment are distorted when the unit is connected via HDMI

- Is the HDMI cable connected properly? (p. 20-21, 27)
- Turn Off the TV unit and equipment, then turn them On again.
- Check an input signal from the equipment. (p. 27)
- Use equipment compliant with EIA/CEA-861/861B.

The remote control does not work

- Are the batteries installed correctly? (p. 6)
- Has the battery run down?
- To operate external equipment of other manufacturers, register the remote control codes. (p. 18, 23-24)

If there is a problem with your TV please refer to the table below to determine the symptoms, then carry out the suggested check. If this does not solve the problem, please contact your local Panasonic dealer, quoting the model number and serial number (both found on the rear of the TV).

Symptoms		Checks
Picture	Sound	
Snowy Picture	Noisy Sound	● Antenna location, direction or connection.
Multiple Images	Normal Sound	● Antenna location, direction or connection.
Interference	Noisy Sound	● Electrical appliances. Cars / Motorcycles. Fluorescent lights.
Normal Picture	No Sound	● Volume level. Sound mute switched on. STEREO/SAP/MONO
No Picture	No Sound	● TV set to AV mode. Not plugged into wall outlet. Not switched on. Picture / Sound controls set at minimum levels.
No color	Normal Sound	● Color controls set at minimum levels. Weak signal.
Poor or Distorted Picture	Weak or No Sound	● Retune Channel (s).
Normal Picture	Weak, Wrong or No Sound	● Sound reception may have deteriorated. Set STEREO/SAP/MONO setting to SAP or MONO until reception improved.
Cannot operate with the remote control.		● The battery/ies is/are exhausted. The batteries' polarity is wrong. The remote control sensor is exposed to strong light from a fluorescent lamp, etc.
The main unit is hot.		● The main unit radiates heat and some of the parts may become hot. This is not a problem for performance or quality. Set up in a location with good ventilation. Do not cover the ventilation holes of the TV with a tablecloth, etc., and do not place on top of other equipment.
There may be red spots, blue spots, green spots and black spots on the screen.		● This is a characteristic of liquid crystal panels and is not a problem. The liquid crystal panel is built with very high precision technology giving you fine picture details. Occasionally, a few non-active pixels may appear on the screen as fixed points of red, blue, green, or black. Please note this does not affect the performance of your LCD.
"Control with HDMI" function does not work		● Switch the TV unit on again with the equipment on. ● Set "Control with HDMI" to "Off", then set to "On" again. (p. 19)

Specifications

	TC-23LX60	TC-26LX60C	TC-26LX60L	TC-32LX60C	TC-32LX60L
Power Source	AC 120 V, 60 Hz	AC 120 V - 127 V, 60 Hz	AC 110 V - 220 V, 50/60 Hz	AC 120 V - 127 V, 60 Hz	AC 110 V - 220 V, 50/60 Hz
Power Consumption	Average use	92 W	107 W	122 W	118 W
	Maximum Current	1.8 A	2.1 A	2.3 A	1.5 A
	Standby condition	0.6 W	0.6 W	0.6 W	0.6 W
	Aspect Ratio	16:9			
Visible screen size (W × H × Diagonal)	23.0" DIAGONAL (58.3 cm DIAGONAL)	26.0" DIAGONAL (66.1 cm DIAGONAL)		31.5" DIAGONAL (80.0 cm DIAGONAL)	
	20.0" × 11.3" × 23.0" (508 mm × 286 mm × 583 mm)	22.7" × 12.8" × 26.0" (576 mm × 324 mm × 661 mm)		27.5" × 15.4" × 31.5" (698 mm × 392 mm × 800 mm)	
	(No. of pixels)	1,049,088 (1,366 (W) × 768(H)) [4,098 × 768 dots]			
Sound	Speaker	2.36" × 4.7" (60 mm × 120 mm) Full-range × 2 pcs			
	Audio Output	8 W [4 W + 4 W] (10 % THD)	20 W [10 W + 10 W] (10 % THD)		
	Headphones	M3 (3.5mm) Jack × 1			
Channel Capability	VHF/UHF: 2-69, CATV: 1-125				
Operating Conditions	Temperature : 32 °F -95 °F (0 °C - 35°C)				
Connection Terminals	INPUT 1-2	VIDEO : RCA PIN Type × 1 1.0 V [p-p] (75 Ω) S VIDEO : Mini DIN 4-pin Y:1.0 V [p-p] (75 Ω) C:0.286 V [p-p] (75 Ω) AUDIO L - R : RCA PIN Type × 2 0.5 V [rms]			
	INPUT 3	-	VIDEO : RCA PIN Type × 1 1.0 V [p-p] (75 Ω) AUDIO L - R : RCA PIN Type × 2 0.5 V [rms]		
	COMPONENT VIDEO INPUT	Y : 1.0 V [p-p] (including synchronization) PB, PR : ±0.35 V [p-p] AUDIO L-R : RCA PIN Type × 2 0.5 V [rms]			
	HDMI AUDIO IN	TYPE A Connector × 1 AUDIO L - R : RCA PIN Type × 2 0.5 V [rms]			
	OUTPUT	VIDEO : RCA PIN Type × 1 1.0 V [p-p] (75 Ω) AUDIO L - R : RCA PIN Type × 2 0.5 V [rms]			
FEATURES	3D Y/C Digital Comb Filter, CLOSED CAPTION, V-Chip HDMI Vesa compatible				
Dimensions (W × H × D)	Including TV stand	22.2" × 17.8" × 10.2" (565 mm × 453 mm × 260 mm)	25.9" × 20.7" × 11.8" (657 mm × 525 mm × 300 mm)	31.1" × 24.2" × 11.8" (791 mm × 615 mm × 300 mm)	
	TV Set only	22.2" × 16.2" × 4.7" (565 mm × 411 mm × 119 mm)	25.9" × 18.6" × 4.6" (657 mm × 473 mm × 117 mm)	31.1" × 22.2" × 4.6" (791 mm × 563 mm × 117 mm)	
Weight	24.2 lb. (11.0 kg) NET		34.1 lb. (15.5 kg) NET		41.8 lb. (19.0 kg) NET

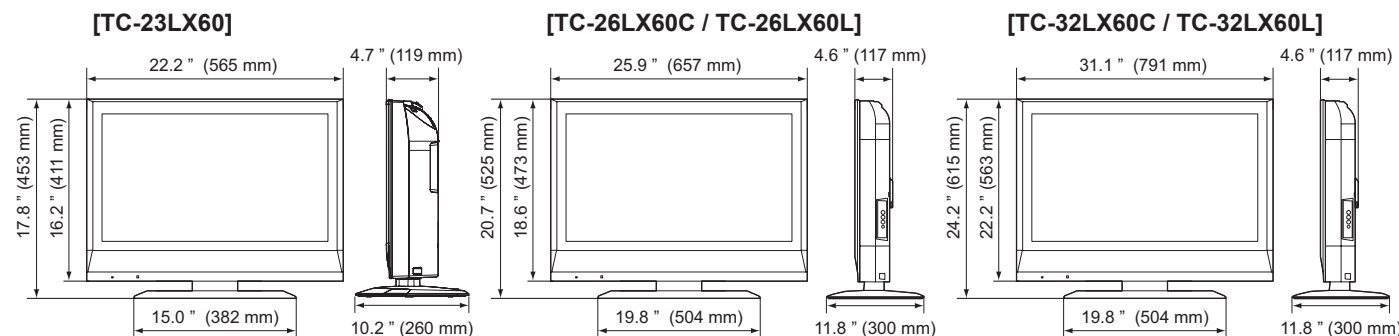

Note

● Design and Specifications are subject to change without notice. Weight and Dimensions shown are approximate.

Limited Warranty (for U.S.A.)

PANASONIC CONSUMER ELECTRONICS COMPANY,
DIVISION OF:
PANASONIC CORPORATION OF NORTH AMERICA
One Panasonic Way
Secaucus, New Jersey 07094

PANASONIC SALES COMPANY,
DIVISION OF:
PANASONIC PUERTO RICO, INC.
Ave. 65 de Infanteria, Km. 9.5
San Gabriel Industrial Park
Carolina, Puerto Rico 00985

Panasonic LCD Televisions Limited Warranty

Limited Warranty Coverage

If your product does not work properly because of a defect in materials or workmanship, Panasonic Consumer Electronics Company or Panasonic Sales Company (collectively referred to as "the warrantor") will, for the length of the period indicated on the chart below, which starts with the date of original purchase ("warranty period"), at its option either (a) repair your product with new or refurbished parts, or (b) replace it with a new or a refurbished product. The decision to repair or replace will be made by the warrantor.

LCD TV CATEGORIES	PARTS	LABOR	SERVICE
Up to 20' (diagonal)	1 (ONE) YEAR	1 (ONE) YEAR	Carry-In or Mail-in
21" (diagonal) and larger			In Home or Carry-in / Mail in

During the "Labor" warranty period there will be no charge for labor. During the "Parts" warranty period, there will be no charge for parts. You must carry-in or mail-in your product during the warranty period. If non-rechargeable batteries are included, they are not warranted. This warranty only applies to products purchased and serviced in the United States or Puerto Rico. This warranty is extended only to the original purchaser of a new product which was not sold "as is". A purchase receipt or other proof of the original purchase date is required for warranty service.

In-Home or Carry-in Service

For In-Home or Carry-In Service in the United States call 1-800-211-PANA(7262) or visit the Panasonic web Site: <http://www.panasonic.com>.

For assistance in Puerto Rico call Panasonic Sales Company (787)-750-4300 or fax (787)-768- 2910.

In-Home service requires clear, complete and easy access to the product by the authorized servicer and does not include removal or re-installation of an installed product. It is possible that certain in-home repairs will not be completed in-home, but will require that the product, or parts of the product, be removed for shop diagnosis and/or repair and then returned.

Limited Warranty Limits And Exclusions

This warranty ONLY COVERS failures due to defects in materials or workmanship, and DOES NOT COVER normal wear and tear or cosmetic damage, nor does it cover markings or retained images on the LCD panel resulting from viewing fixed images (including, among other things, letterbox pictures on standard 4:3 screen TV's, or non-expanded standard 4:3 pictures on wide screen TV's, or onscreen data in a stationary and fixed location). The warranty ALSO DOES NOT COVER damages which occurred in shipment, or failures which are caused by products not supplied by the warrantor, or failures which result from accidents, misuse, abuse, neglect, bug infestation, mishandling, misapplication, alteration, faulty installation, set-up adjustments, misadjustment of consumer controls, improper maintenance, power line surge, lightning damage, modification, or commercial use (such as in a hotel, office, restaurant, or other business), rental use of the product, service by anyone other than a Factory Servicenter or other Authorized Servicer, or damage that is attributable to acts of God.

THERE ARE NO EXPRESS WARRANTIES EXCEPT AS LISTED UNDER "LIMITED WARRANTY COVERAGE". THE WARRANTOR IS NOT LIABLE FOR INCIDENTAL OR CONSEQUENTIAL DAMAGES RESULTING FROM THE USE OF THIS PRODUCT, OR ARISING OUT OF ANY BREACH OF THIS WARRANTY. (As examples, this excludes damages for lost time, cost of having someone remove or re-install an installed unit if applicable, or travel to and from the servicer. The items listed are not exclusive, but are for illustration only.) **ALL EXPRESS AND IMPLIED WARRANTIES, INCLUDING THE WARRANTY OF MERCHANTABILITY, ARE LIMITED TO THE PERIOD OF THE LIMITED WARRANTY.**

Some states do not allow the exclusion or limitation of incidental or consequential damages, or limitations on how long an implied warranty lasts, so the exclusions may not apply to you.

This warranty gives you specific legal rights and you may also have others rights which vary from state to state. If a problem with this product develops during or after the warranty period, you may contact your dealer or Servicenter. If the problem is not handled to your satisfaction, then write to the warrantor's Consumer Affairs Department at the addresses listed for the warrantor.

PARTS AND SERVICE (INCLUDING COST OF AN IN-HOME SERVICE CALL, WHERE APPLICABLE) WHICH ARE NOT COVERED BY THIS LIMITED WARRANTY ARE YOUR RESPONSIBILITY.

Customer Services Directory (for U.S.A.)

Customer Services Directory

Obtain Product Information and Operating Assistance; locate your nearest Dealer or Servicenter; purchase Parts and Accessories; or make Customer Service and Literature requests by visiting our Web Site at:

<http://www.panasonic.com/consumersupport>

or, contact us via the web at:

<http://www.panasonic.com/contactinfo>

You may also contact us directly at:

1-800-211-PANA (7262)

Monday-Friday 9 am-9 pm; Saturday-Sunday 10 am-7 pm, EST.

■ For hearing or speech impaired TTY users, TTY : 1-877-833-8855

Accessory Purchases

Purchase Parts, Accessories and Instruction Books on line for all Panasonic Products by visiting our Web Site at:

<http://www.pasc.panasonic.com>

or, send your request by E-mail to:

npcparts@us.panasonic.com

You may also contact us directly at:

1-800-332-5368 (Phone) 1-800-237-9080 (Fax Only) (Monday - Friday 9 am to 8 pm, EST.)

Panasonic Services Company

20421 84th Avenue South,

Kent, WA 98032

(We Accept Visa, MasterCard, Discover Card, American Express, and Personal Checks)

■ For hearing or speech impaired TTY users, TTY : 1-866-605-1277

Service in Puerto Rico

Panasonic Puerto Rico, Inc.

Ave. 65 de Infantería, Km. 9.5, San Gabriel Industrial Park,

Carolina, Puerto Rico 00985

Phone (787)750-4300, Fax (787)768-2910

Limited Warranty (for Canada)

Panasonic Canada Inc.

PANASONIC PRODUCT - LIMITED WARRANTY

Panasonic Canada Inc. warrants this product to be free from defects in material and workmanship and agrees to remedy any such defect for a period as stated below from the date of original purchase.

Plasma TV / Monitor	In-home service	One (1) year, parts (including Plasma Panel) and labour.
LCD TV (26 in & over)	In-home service	One (1) year, parts (including LCD Panel) and labour.
LCD TV (25 in & under)	Carry-in service only	One (1) year, parts (including LCD Panel) and labour.

In-home Service will be carried out only to locations accessible by roads and within 50 km of an authorized Panasonic service facility.

LIMITATIONS AND EXCLUSIONS

This warranty does not apply to products purchased outside Canada or to any product which has been improperly installed, subjected to usage for which the product was not designed, misused or abused, damaged during shipping, or which has been altered or repaired in any way that affects the reliability or detracts from the performance, nor does it cover any product which is used commercially. Dry cell batteries are also excluded from coverage under this warranty.

This warranty is extended to the original end user purchaser only. A purchase receipt or other proof of date of original purchase is required before warranty service is performed.

THIS EXPRESS, LIMITED WARRANTY IS IN LIEU OF ALL OTHER WARRANTIES, EXPRESS OR IMPLIED, INCLUDING ANY IMPLIED WARRANTIES OF MERCHANTABILITY AND FITNESS FOR A PARTICULAR PURPOSE. IN NO EVENT WILL PANASONIC CANADA INC. BE LIABLE FOR ANY SPECIAL, INDIRECT OR CONSEQUENTIAL DAMAGES.

In certain instances, some jurisdictions do not allow the exclusion or limitation of incidental or consequential damages, or the exclusion of implied warranties, so the above limitations and exclusions may not be applicable.

In-home service requires clear, complete and easy access to the product by the Authorized Servicentre and does not include removal or re-installation of an installed product. If removal is required to service the product, it will be at the discretion of the Servicentre and in no event will Panasonic Canada Inc. or the Servicentre be liable for any special, indirect or consequential damages.

WARRANTY SERVICE

For product operation and information assistance, please contact:

Our Customer Care Centre:	Telephone #:	(905) 624-5505
	1-800 #:	1-800-561-5505
	Fax #:	(905) 238-2360
	Email link:	"Customer support" on www.panasonic.ca

FOR PRODUCT REPAIRS, please locate your nearest Authorized Servicentre at www.panasonic.ca :

Link: "Servicentres™ locator" under "Customer support"

IF YOU SHIP THE PRODUCT TO A SERVICENTRE

Carefully pack and send prepaid, adequately insured and preferably in the original carton. Include details of the defect claimed, and proof of date of original purchase.